

## SAR TEST REPORT

For

Purism SPC

mobile phone

Test Model: Librem 5

Prepared for : Purism SPC  
Address : One Market Street, 36th Floor, San Francisco, CA 94105, USA

Prepared by : Shenzhen LCS Compliance Testing Laboratory Ltd.  
Address : Room 101, 201, Building A and Room 301, Building C, Juji Industrial Park, Yabianxueziwei, Shajing Street, Bao'an District, Shenzhen, Guangdong, China

Tel : (86)755-82591330  
Fax : (86)755-82591332  
Web : www.LCS-cert.com  
Mail : webmaster@LCS-cert.com

Date of receipt of test sample : April 26, 2021  
Number of tested samples : 1  
Serial number : Prototype  
Date of Test : April 26, 2021~May 30, 2021  
Date of Report : June 15, 2021



**SAR TEST REPORT**

<b>Report Reference No.....:</b>	<b>LCS210421038AEB</b>
Date Of Issue.....:	June 15, 2021
<b>Testing Laboratory Name.....:</b>	<b>Shenzhen LCS Compliance Testing Laboratory Ltd.</b>
Address.....:	Room 101, 201, Building A and Room 301, Building C, Juji Industrial Park, Yabianxueziwei, Shajing Street, Bao'an District, Shenzhen, Guangdong, China
Testing Location/ Procedure.....:	Full application of Harmonised standards <input checked="" type="checkbox"/> Partial application of Harmonised standards <input type="checkbox"/> Other standard testing method <input type="checkbox"/>
<b>Applicant's Name.....:</b>	<b>Purism SPC</b>
Address.....:	One Market Street, 36th Floor, San Francisco, CA 94105, USA
<b>Test Specification:</b>	
SAR Max. Values is.....:	0.616W/kg (10g) for Head and 1.020W/kg (10g) for Body.
Standard.....:	EN50360:2017&EN50663:2017&EN50566:2017&EN62209-1:2016&EN62209-2:2010+A1:2019
Test Report Form No.....:	LCSEMC-1.0
TRF Originator.....:	Shenzhen LCS Compliance Testing Laboratory Ltd.
Master TRF.....:	Dated 2017-12
<b>Shenzhen LCS Compliance Testing Laboratory Ltd. All rights reserved.</b>	
This publication may be reproduced in whole or in part for non-commercial purposes as long as the Shenzhen LCS Compliance Testing Laboratory Ltd. is acknowledged as copyright owner and source of the material. Shenzhen LCS Compliance Testing Laboratory Ltd. takes no responsibility for and will not assume liability for damages resulting from the reader's interpretation of the reproduced material due to its placement and context.	
<b>Test Item Description.....:</b>	<b>mobile phone</b>
Trade Mark.....:	Purism
Model/Type Reference.....:	Librem 5
Ratings.....:	For AC Adapter: Input: 100-240V~, 50/60Hz, 0.6A Output: 5V=3A, 9V=2A, 12V=1.5A DC 3.8V by Rechargeable Li-ion Battery(4500mAh)
<b>Result .....</b>	<b>Positive</b>

**Compiled by:**  
Ping Li

Ping Li/ File administrators

**Supervised by:**  
Jin Wang

Jin Wang/ Technique principal



**Approved by:**  
Gavin Liang/ Manager

**SAR -- TEST REPORT****Test Report No. : LCS210421038AEB**June 15, 2021  
Date of issue

Type / Model..... : Librem 5

EUT..... : mobile phone

**Applicant..... : Purism SPC**Address..... : One Market Street, 36th Floor, San Francisco, CA 94105,  
USA

Telephone..... : /

Fax..... : /

**Manufacturer..... : Purism SPC**Address..... : One Market Street, 36th Floor, San Francisco, CA 94105,  
USA

Telephone..... : /

Fax..... : /

**Factory..... : Purism SPC**Address..... : One Market Street, 36th Floor, San Francisco, CA 94105,  
USA

Telephone..... : /

Fax..... : /

**Test Result****Positive**

The test report merely corresponds to the test sample.

It is not permitted to copy extracts of these test result without the written permission of the test laboratory.

### Revision History

Revision	Issue Date	Revisions	Revised By
000	June 15, 2021	Initial Issue	Gavin Liang

## TABLE OF CONTENTS

<b>1. TEST STANDARDS AND TEST DESCRIPTION.....</b>	<b>6</b>
1.1. TEST STANDARDS.....	6
1.2. TEST DESCRIPTION.....	6
1.3. PRODUCT DESCRIPTION.....	7
1.4. SUMMARY SAR RESULTS.....	10
1.5. EUT OPERATION MODE.....	10
1.6. EUT CONFIGURATION.....	10
<b>2. TEST ENVIRONMENT.....</b>	<b>11</b>
2.1. TEST FACILITY.....	11
2.2. ENVIRONMENTAL CONDITIONS.....	11
2.3. SAR LIMITS.....	11
2.4. EQUIPMENTS USED DURING THE TEST.....	12
<b>3. SAR MEASUREMENTS SYSTEM CONFIGURATION.....</b>	<b>13</b>
3.1. SAR MEASUREMENT SET-UP.....	13
3.2. OPENSAR E-FIELD PROBE SYSTEM.....	14
3.3. PHANTOMS.....	15
3.4. DEVICE HOLDER.....	15
3.5. SCANNING PROCEDURE.....	16
3.6. DATA STORAGE AND EVALUATION.....	16
3.7. POSITION OF THE WIRELESS DEVICE IN RELATION TO THE PHANTOM.....	17
3.8. TISSUE DIELECTRIC PARAMETERS FOR HEAD AND BODY PHANTOMS.....	24
3.9. TEST CONDITION AND DIELECTRIC PERFORMANCE.....	25
3.10. SYSTEM CHECK.....	25
3.11. MEASUREMENT PROCEDURES.....	26
<b>4. TEST CONDITIONS AND RESULTS.....</b>	<b>32</b>
4.1. CONDUCTED POWER RESULTS.....	32
4.2. TEST REDUCTION PROCEDURE.....	42
4.3. SAR MEASUREMENT RESULTS.....	44
4.4. MEASUREMENT UNCERTAINTY (450MHZ-6GHZ).....	49
4.5. SYSTEM CHECK RESULTS.....	50
4.6. SAR TEST GRAPH RESULTS.....	56
<b>5. CALIBRATION CERTIFICATE.....</b>	<b>84</b>
5.1. PROBE-EPGO324 CALIBRATION CERTIFICATE.....	86
5.2. SID900 DIPOLE CALIBRATION CERTIFICATE.....	96
5.3. SID1800 DIPOLE CALIBRATION CERTIFICATE.....	107
5.4. SID2000 DIPOLE CALIBRATION CERTIFICATE.....	115
5.5. SID2450 DIPOLE CALIBRATION CERTIFICATE.....	126
5.6. SID2600 DIPOLE CALIBRATION CERTIFICATE.....	137
5.7. SID5G-6G DIPOLE CALIBRATION CERTIFICATE.....	147
<b>6. SAR SYSTEM PHOTOGRAPHS.....</b>	<b>160</b>
<b>7. SETUP PHOTOGRAPHS.....</b>	<b>161</b>
<b>8. EUT PHOTOGRAPHS.....</b>	<b>164</b>

# 1. TEST STANDARDS AND TEST DESCRIPTION

## 1.1. Test Standards

The tests were performed according to following standards:

EN 50360:2017:Product standard to demonstrate the compliance of wireless communication devices, with the basic restrictions and exposure limit values related to human exposure to electromagnetic fields in the frequency range from 300 MHz to 6 GHz: devices used next to the ear

EN 62209-1:2016: Measurement procedure for the assessment of specific absorption rate of human exposure to radio frequency fields from hand-held and body-mounted wireless communication devices - Part 1: Devices used next to the ear (Frequency range of 300 MHz to 6 GHz)

EN 62209-2:2010+A1:2019: Human exposure to radio frequency fields from hand-held and body-mounted wireless communication devices. Human models, instrumentation, and procedures. Part 2: Procedure to determine the specific absorption rate (SAR) for wireless communication devices used in close proximity to the human body (frequency range of 30 MHz to 6 GHz)

EN 50663:2017: Generic standard for assessment of low power electronic and electrical equipment related to human exposure restrictions for electromagnetic fields (10 MHz - 300 GHz)

EN 50566:2017: Product standard to demonstrate the compliance of wireless communication devices with the basic restrictions and exposure limit values related to human exposure to electromagnetic fields in the frequency range from 30 MHz to 6 GHz: hand-held and body mounted devices in close proximity to the human body

## 1.2. Test Description

The EUT battery must be fully charged and checked periodically during the test to ascertain uniform power

**1.3. Product Description**

Product Name:	mobile phone
Model/Type reference:	Librem 5
Hardware Version:	Librem5_V1.0.6
Software Version:	PureOS 9.0
Power supply:	For AC Adapter: Input: 100-240V~, 50/60Hz, 0.6A Output: 5V==3A, 9V==2A, 12V==1.5A DC 3.8V by Rechargeable Li-ion Battery(4500mAh)
<b>2G</b>	
Support Band:	<input checked="" type="checkbox"/> GSM 900 (EU-Band) <input checked="" type="checkbox"/> DCS 1800 (EU-Band) <input checked="" type="checkbox"/> GSM 850 (U.S.-Band) <input checked="" type="checkbox"/> PCS 1900 (U.S.-Band)
Power Class:	GSM 900: Level 5, DCS 1800: Level 0
Uplink:	GSM 900: 880MHz ~ 915MHz DCS 1800: 1710MHz ~1785MHz
Downlink:	GSM 900: 925MHz ~ 960MHz DCS 1800: 1805MHz ~ 1880MHz
Modulation Type:	GMSK for GSM/GPRS; 8PSK for EGPRS
GSM Release Version:	R10
GPRS Multislot Class:	Class 12
EGPRS Class:	Class 12
Antenna Description:	PIFA Antenna -0.57dBi (max.) For GSM 900 -0.23dBi (max.) For DCS 1800
<b>WCDMA</b>	
Support Band:	<input checked="" type="checkbox"/> WCDMA Band II (U.S.-Band) <input checked="" type="checkbox"/> WCDMA Band V (U.S.-Band) <input type="checkbox"/> WCDMA Band IV (U.S.-Band) <input checked="" type="checkbox"/> WCDMA Band I (EU-Band) <input checked="" type="checkbox"/> WCDMA Band VIII (EU-Band)
Power Class:	Level 3
Uplink:	WCDMA Band I: 1920MHz ~ 1980MHz WCDMA Band VIII: 880MHz~915MHz
Downlink:	WCDMA Band I: 2110MHz ~ 2170MHz WCDMA Band VIII: 925MHz~960MHz
Modulation Type:	WCDMA: BPSK; HSDPA/HSUPA: BPSK
Release Version:	R10
DC-HSUPA Release Version:	Not Supported
Antenna Description:	PIFA Antenna 0.87dBi (max.) For WCDMA Band I -0.57dBi (max.) For WCDMA Band VIII
<b>LTE</b>	
Support Band:	<input checked="" type="checkbox"/> E-UTRA Band 1(EU-Band) <input checked="" type="checkbox"/> E-UTRA Band 2(Non EU-Band) <input checked="" type="checkbox"/> E-UTRA Band 3(EU-Band) <input checked="" type="checkbox"/> E-UTRA Band 5(Non EU-Band) <input checked="" type="checkbox"/> E-UTRA Band 7(EU-Band) <input checked="" type="checkbox"/> E-UTRA Band 8(EU-Band) <input checked="" type="checkbox"/> E-UTRA Band 20(EU-Band) <input checked="" type="checkbox"/> E-UTRA Band 38(EU-Band)

	<input checked="" type="checkbox"/> E-UTRA Band 40(EU-Band) <input checked="" type="checkbox"/> E-UTRA Band 41(Non EU-Band)
Power Class:	Class 3
FDD Band:	Uplink: E-UTRA Band 1: 1920MHz ~ 1980MHz E-UTRA Band 3: 1710MHz~1785MHz E-UTRA Band 7: 2500MHz ~ 2570MHz E-UTRA Band 8: 880MHz ~ 915MHz E-UTRA Band 20: 832MHz ~ 862MHz Downlink: E-UTRA Band 1: 2110MHz ~ 2170MHz E-UTRA Band 3: 1805MHz~1880MHz E-UTRA Band 7: 2620MHz ~ 2690MHz E-UTRA Band 8: 758MHz ~ 803MHz E-UTRA Band 20: 791MHz ~ 821MHz
TDD Band:	E-UTRA Band 38: 2570MHz ~ 2620MHz E-UTRA Band 40: 2300MHz ~ 2400MHz
Modulation Type:	QPSK,16QAM
LTE Release Version:	R10
Antenna Description:	PIFA Antenna 0.87dBi (max.) For E-UTRA Band 1 -0.23dBi (max.) For E-UTRA Band 3 1.95dBi (max.) For E-UTRA Band 7 -0.57dBi (max.) For E-UTRA Band 8 -0.28dBi (max.) For E-UTRA Band 20 2.07dBi (max.) For E-UTRA Band 38 1.57dBi (max.) For E-UTRA Band 40
<b>WIFI(2.4G Band)</b>	
Frequency Range:	2412MHz ~ 2472MHz
Modulation:	802.11b: DSSS; 802.11g/n: OFDM
Channel number:	13 Channel for 20MHz bandwidth(2412~2472MHz) 9 channels for 40MHz bandwidth(2422~2462MHz)
Channel separation:	5MHz
Antenna Description:	PIFA Antenna, -0.51dBi(Max.)
<b>WIFI(5.2G Band)</b>	
Frequency Range:	5180MHz ~ 5240MHz
Channel Number	4 channels for 20MHz bandwidth(5180-5240MHz) 2 channels for 40MHz bandwidth(5190~5230MHz)
Modulation Type	802.11a/n: OFDM (64QAM, 16QAM, QPSK, BPSK)
Antenna Description:	PIFA Antenna, -0.51dBi(Max.)
<b>SRD(5.8G Band)</b>	
Frequency Range	5745MHz ~ 5825MHz
Channel Number	5 channels for 20MHz bandwidth(5745-5825MHz) 2 channels for 40MHz bandwidth(5755~5795MHz)
Modulation Type	802.11a/n: OFDM (64QAM, 16QAM, QPSK, BPSK)



Antenna Description:	PIFA Antenna, -0.51dBi(Max.)
<b>Bluetooth</b>	
Version:	Supported BT V5.0
Modulation:	GFSK, $\pi/4$ -DQPSK, 8-DPSK for Bluetooth V5.0 (BDR/EDR) GFSK for Bluetooth V5.0 (BT LE/ BT 2LE)
Operation frequency:	2402MHz~2480MHz
Channel number:	79/40
Channel separation:	1MHz/2MHz
Antenna Description:	PIFA Antenna, -0.51dBi(Max.)
<b>GPS Receiver</b>	
GPS Receiving Frequency:	1575.42MHz
Channel Number:	3
<b>GLONASS Receiver</b>	
Receive Frequency:	1602.5625MHz, 1246.4375MHz
Channel Number:	2
<b>Galileo Receiver</b>	
Receive Frequency:	1589.74MHz, 1176.45MHz, 1207.14MHz
Antenna Description:	PIFA Antenna,
Receive Frequency:	1589.74MHz, 1176.45MHz, 1207.14MHz

## 1.4. Summary SAR Results

Table 1:Max. SAR Measured(10g)

Exposure Configuration	Technolohy Band	Highest Measured SAR 10g(W/kg)
Head	GSM900	0.093
	DCS1800	0.009
	WCDMA Band VIII	<b>0.616</b>
	WCDMA Band I	0.228
	WLAN2450	0.172
	WLAN5200	0.219
	WLAN5800	0.248
	E-UTRA Band 1	0.096
	E-UTRA Band 3	0.083
	E-UTRA Band 7	0.072
	E-UTRA Band 8	0.593
	E-UTRA Band 20	0.104
	E-UTRA Band 38	0.047
	E-UTRA Band 40	0.051
Body-worn	GSM900	0.057
	DCS1800	0.006
	WCDMA Band VIII	0.337
	WCDMA Band I	0.507
	WLAN2450	0.292
	WLAN5200	0.268
	WLAN5800	0.361
	E-UTRA Band 1	0.427
	E-UTRA Band 3	<b>1.020</b>
	E-UTRA Band 7	1.006
	E-UTRA Band 8	0.109
	E-UTRA Band 20	0.078
	E-UTRA Band 38	0.357
	E-UTRA Band 40	0.693

Note:

- 1.The SAR values found for the EUT below the maximum recommended levels of 2.0W/Kg as averaged over for 10g tissue according to EN62209.
- 2.The maximum SAR value is obtained at the case of (Table 1), and the maximum value is:0.616W/kg (10g) for Head and 1.020W/kg (10g) for Body.
3. The EUT has two SIM card slots(SIM1 and SIM2). The result for GSM/WCDMA/LTE card slot(SIM1) is the worst case which was only recorded.

## 1.5. EUT operation mode

The EUT has been tested under typical operating condition and The Transmitter was operated in the normal operating mode. The TX frequency was fixed which was for the purpose of the measurements.

## 1.6. EUT configuration

The following peripheral devices and interface cables were connected during the measurement:

- - supplied by the manufacturer
- - supplied by the lab

<input type="radio"/>	Power Cable	Length (m) :	/
		Shield :	/
		Detachable :	/
<input type="radio"/>	Multimeter	Manufacturer :	/
		Model No. :	/

## 2. TEST ENVIRONMENT

### 2.1. Test Facility

The test facility is recognized, certified, or accredited by the following organizations:

Site Description

EMC Lab.

: NVLAP Accreditation Code is 600167-0.  
FCC Designation Number is CN5024.  
CAB identifier is CN0071.  
CNAS Registration Number is L4595.

### 2.2. Environmental conditions

During the measurement the environmental conditions were within the listed ranges:

Temperature:	18-25 ° C
Humidity:	40-65 %
Atmospheric pressure:	950-1050mbar

### 2.3. SAR Limits

EXPOSURE LIMITS	CE Limit (10g Tissue)	
	SAR (W/kg)	
	(General Population / Uncontrolled Exposure Environment)	(Occupational / Controlled Exposure Environment)
Spatial Average(averaged over the whole body)	0.08	0.4
Spatial Peak(averaged over any 1 g of tissue)	2.0	10
Spatial Peak(hands/wrists/ feet/anklesaveraged over 10 g)	4.0	20.0

Population/Uncontrolled Environments are defined as locations where there is the exposure of individual who have no knowledge or control of their exposure.

Occupational/Controlled Environments are defined as locations where there is exposure that may be incurred by people who are aware of the potential for exposure (i.e. as a result of employment or occupation).

**2.4. Equipments Used during the Test**

Item	Equipment	Manufacturer	Model No.	Serial No.	Cal Date	Due Date
1	PC	Lenovo	G5005	MY42081102	N/A	N/A
2	SAR Measurement system	SATIMO	4014_01	SAR_4014_01	N/A	N/A
3	Signal Generator	Agilent	E4438C	MY49072627	2020-06-11	2021-06-10
4	Multimeter	Keithley	MiltiMeter 2000	4059164	2020-11-15	2021-11-14
5	S-parameter Network Analyzer	Agilent	8753ES	US38432944	2020-11-15	2021-11-14
6	Wideband Radio Communication Tester	R&S	CMW500	103818-1	2020-11-22	2021-11-21
7	E-Field PROBE	MVG	SSE2	SN 31/17 EPGO324	2020-10-07	2021-10-06
8	DIPOLE 900	SATIMO	SID 900	SN 07/14 DIP 0G900-300	2018-10-01	2021-09-30
9	DIPOLE 1800	SATIMO	SID 1800	SN 07/14 DIP 1G800-301	2018-10-01	2021-09-30
10	DIPOLE 2000	SATIMO	SID 2000	SN 07/14 DIP 2G000-305	2018-10-01	2021-09-30
11	DIPOLE 2450	SATIMO	SID 2450	SN 07/14 DIP 2G450-306	2018-10-01	2021-09-30
12	DIPOLE 2600	SATIMO	SID 2600	SN 38/18 DIP 2G600-468	2018-09-24	2021-09-23
13	DIPOLE 5000-6000	SATIMO	SWG5500	SN 49/16 WGA 43	2018-09-24	2021-09-23
14	COMOSAR OPENCoaxial Probe	SATIMO	OCPG 68	SN 40/14 OCPG68	2020-11-15	2021-11-14
15	SAR Locator	SATIMO	VPS51	SN 40/14 VPS51	2020-11-15	2021-11-14
16	Communication Antenna	SATIMO	ANTA57	SN 39/14 ANTA57	2020-11-15	2021-11-14
17	FEATURE PHONEPOSITIONING DEVICE	SATIMO	MSH98	SN 40/14 MSH98	N/A	N/A
18	DUMMY PROBE	SATIMO	DP60	SN 03/14 DP60	N/A	N/A
19	SAM PHANTOM	SATIMO	SAM117	SN 40/14 SAM117	N/A	N/A
20	Liquid measurement Kit	HP	85033D	3423A03482	2020-11-15	2021-11-14
21	Power meter	Agilent	E4419B	MY45104493	2020-06-11	2021-06-10
22	Power meter	Agilent	E4419B	MY45100308	2020-11-22	2021-11-21
23	Power sensor	Agilent	E9301H	MY41495616	2020-11-22	2021-11-21
24	Power sensor	Agilent	E9301H	MY41495234	2020-06-11	2021-06-10
25	Directional Coupler	MCLI/USA	4426-20	03746	2020-06-11	2021-06-10

### 3.SAR MEASUREMENTS SYSTEM CONFIGURATION

#### 3.1. SAR Measurement Set-up

The OPENSAR system for performing compliance tests consist of the following items:

A standard high precision 6-axis robot (KUKA) with controller and software.

KUKA Control Panel (KCP)

A dosimetric probe, i.e., an isotropic E-field probe optimized and calibrated for usage in tissue simulating liquid. The probe is equipped with a Video Positioning System(VPS).

The stress sensor is composed with mechanical and electronic when the electronic part detects a change on the electro-mechanical switch,It sends an "Emergency signal" to the robot controller that to stop robot's moves

A computer operating Windows XP.

OPENSAR software

Remote control with teaches pendant and additional circuitry for robot safety such as warning lamps, etc.

The SAM phantom enabling testing left-hand right-hand and body usage.

The Position device for handheld EUT

Tissue simulating liquid mixed according to the given recipes .

System validation dipoles to validate the proper functioning of the system.

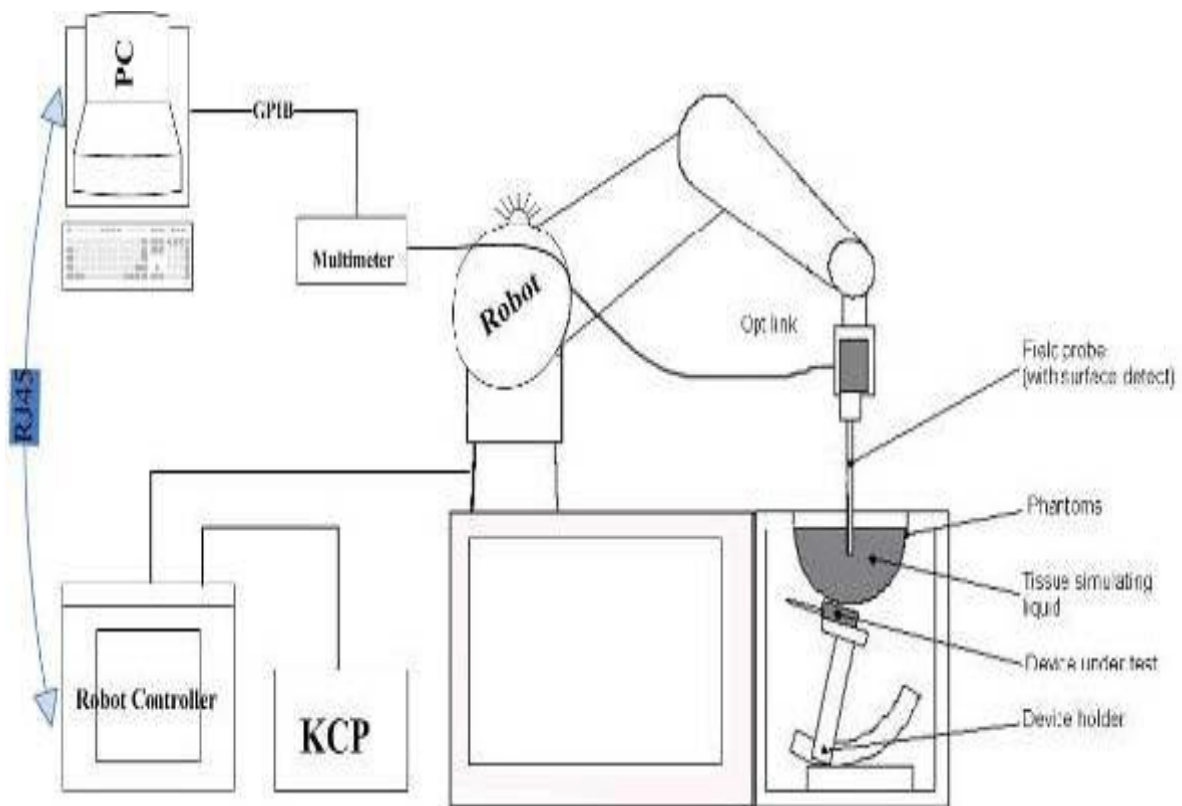

### 3.2. OPENSAR E-field Probe System

The SAR measurements were conducted with the dosimetric probe EPGO324 (manufactured by SATIMO), designed in the classical triangular configuration and optimized for dosimetric evaluation.

#### Probe Specification

Construction Symmetrical design with triangular core

Interleaved sensors

Built-in shielding against static charges

PEEK enclosure material (resistant to organic solvents, e.g., DGBE)

Calibration ISO/IEC 17025 calibration service available.

Frequency	450 MHz to 6 GHz; Linearity: 0.25dB(450 MHz to 6 GHz)
Directivity	0.25 dB in HSL (rotation around probe axis) 0.5 dB in tissue material (rotation normal to probe axis)
Dynamic Range	0.01W/kg to > 100 W/kg; Linearity: 0.25 dB
Dimensions	Overall length: 330 mm (Tip: 16mm) Tip diameter: 5 mm (Body: 8 mm) Distance from probe tip to sensor centers: 2.5 mm
Application	General dosimetry up to 6 GHz Dosimetry in strong gradient fields Compliance tests of Mobile Phones

#### Isotropic E-Field Probe

The isotropic E-Field probe has been fully calibrated and assessed for isotropicity, and boundary effect within a controlled environment. Depending on the frequency for which the probe is calibrated the method utilized for calibration will change.

The E-Field probe utilizes a triangular sensor arrangement as detailed in the diagram below:

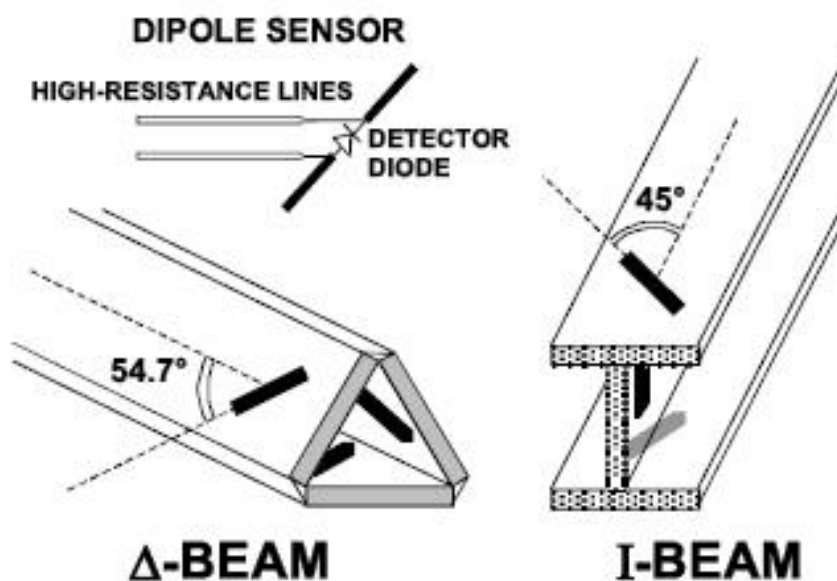

### 3.3. Phantoms

The SAM Phantom SAM117 is constructed of a fiberglass shell integrated in a wooden table. The shape of the shell is in compliance with the specification set in IEEE P1528 and CENELEC EN62209-1, EN62209-2:2010. The phantom enables the dosimetric evaluation of left and right hand phone usage as well as body mounted usage at the flat phantom region. A cover prevents the evaporation of the liquid. Reference markings on the Phantom allow the complete setup of all predefined phantom positions and measurement grids by manually teaching three points in the robot.

System checking was performed using the flat section, whilst Head SAR tests used the left and right head profile sections. Body SAR testing also used the flat section between the head profiles.

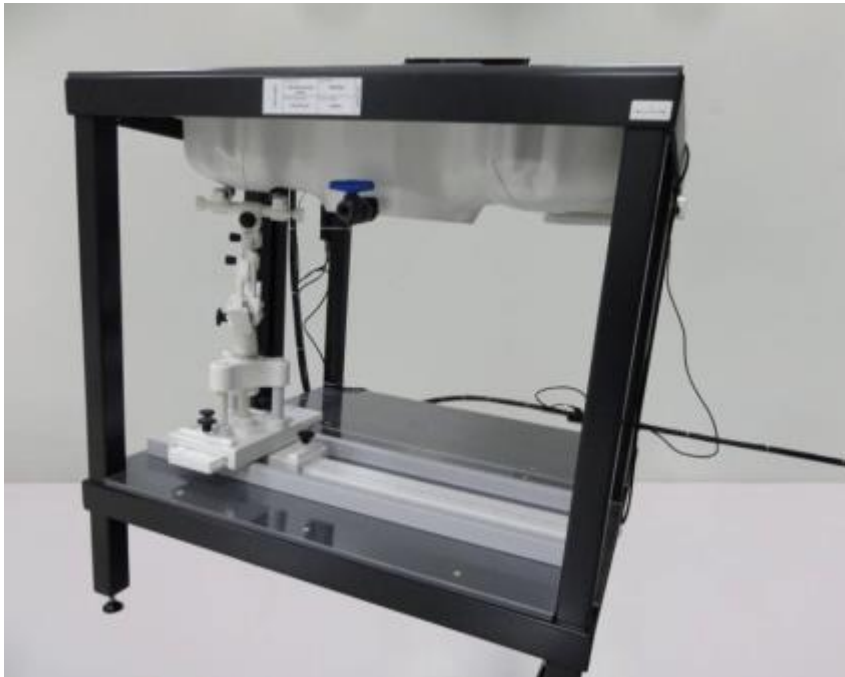

SAM Twin Phantom

### 3.4. Device Holder

In combination with the Generic Twin Phantom SAM117, the Mounting Device enables the rotation of the mounted transmitter in spherical coordinates whereby the rotation points is the ear opening. The devices can be easily, accurately, and repeatedly positioned according to the FCC and CENELEC specifications. The device holder can be locked at different phantom locations (left head, right head, flat phantom).



Device holder supplied by SATIMO

### 3.5. Scanning Procedure

The procedure for assessing the peak spatial-average SAR value consists of the following steps

#### Power Reference Measurement

The reference and drift jobs are useful jobs for monitoring the power drift of the device under test in the batch process. Both jobs measure the field at a specified reference position, at a selectable distance from the phantom surface. The reference position can be either the selected section's grid reference point or a user point in this section. The reference job projects the selected point onto the phantom surface, orients the probe perpendicularly to the surface, and approaches the surface using the selected detection method.

#### Area Scan

The area scan is used as a fast scan in two dimensions to find the area of high field values, before doing a finer measurement around the hot spot. The sophisticated interpolation routines implemented in OPENSAR software can find the maximum locations even in relatively coarse grids. The scan area is defined by an editable grid. This grid is anchored at the grid reference point of the selected section in the phantom. When the area scan's property sheet is brought-up, grid was at to 15 mm by 15 mm and can be edited by a user.

#### Zoom Scan

Zoom scans are used to assess the peak spatial SAR values within a cubic averaging volume containing 1 g and 10 g of simulated tissue. The default zoom scan measures 5 x 5 x 4 points within a cube whose base faces are centered around the maximum found in a preceding area scan job within the same procedure. If the preceding Area Scan job indicates more than one maximum, the number of Zoom Scans has to be enlarged accordingly (The default number inserted is 1).

#### Power Drift measurement

The drift job measures the field at the same location as the most recent reference job within the same procedure, and with the same settings. The drift measurement gives the field difference in dB from the reading conducted within the last reference measurement. Several drift measurements are possible for one reference measurement. This allows a user to monitor the power drift of the device under test within a batch process. In the properties of the Drift job, the user can specify a limit for the drift and have OPENSAR software stop the measurements if this limit is exceeded.

### 3.6. Data Storage and Evaluation

#### Data Storage

The OPENSAR software stores the acquired data from the data acquisition electronics as raw data (in microvolt readings from the probe sensors), together with all necessary software parameters for the data evaluation (probe calibration data, liquid parameters and device frequency and modulation data) in measurement files. The software evaluates the desired unit and format for output each time the data is visualized or exported. This allows verification of the complete software setup even after the measurement and allows correction of incorrect parameter settings. For example, if a measurement has been performed with a wrong crest factor parameter in the device setup, the parameter can be corrected afterwards and the data can be re-evaluated.

The measured data can be visualized or exported in different units or formats, depending on the selected probe type ([V/m], [A/m], [°C], [mW/g], [mW/cm<sup>2</sup>], [dBrel], etc.). Some of these units are not available in certain situations or show meaningless results, e.g., a SAR output in a lossless media will always be zero. Raw data can also be exported to perform the evaluation with other software packages.

#### Data Evaluation

The OPENSAR software automatically executes the following procedures to calculate the field units from the microvolt readings at the probe connector. The parameters used in the evaluation are stored in the configuration modules of the software:

Probe parameters:	- Sensitivity	Normi, ai0, ai1, ai2
	- Conversion factor	ConvFi
	- Diode compression point	Dcpi
Device parameters:	- Frequency	f
	- Crest factor	cf
Media parameters:	- Conductivity	$\sigma$
	- Density	$\rho$



These parameters must be set correctly in the software. They can be found in the component documents or they can be imported into the software from the configuration files issued for the OPENSAR components. In the direct measuring mode of the multimeter option, the parameters of the actual system setup are used. In the scan visualization and export modes, the parameters stored in the corresponding document files are used.

The first step of the evaluation is a linearization of the filtered input signal to account for the compression characteristics of the detector diode. The compensation depends on the input signal, the diode type and the DC-transmission factor from the diode to the evaluation electronics. If the exciting field is pulsed, the crest factor of the signal must be known to correctly compensate for peak power. The formula for each channel can be given as:

$$V_i = U_i + U_i^2 \cdot \frac{cf}{dcpi}$$

With  $V_i$  = compensated signal of channel  $i$  ( $i = x, y, z$ )  
 $U_i$  = input signal of channel  $i$  ( $i = x, y, z$ )  
 $cf$  = crest factor of exciting field  
 $dcpi$  = diode compression point

From the compensated input signals the primary field data for each channel can be evaluated:

$$\text{E - fieldprobes : } E_i = \sqrt{\frac{V_i}{Norm_i \cdot ConvF}}$$

$$\text{H - fieldprobes : } H_i = \sqrt{V_i} \cdot \frac{a_{i0} + a_{i1}f + a_{i2}f^2}{f}$$

With  $V_i$  = compensated signal of channel  $i$  ( $i = x, y, z$ )  
 $Norm_i$  = sensor sensitivity of channel  $i$  ( $i = x, y, z$ )  
 [mV/(V/m)<sup>2</sup>] for E-field Probes  
 $ConvF$  = sensitivity enhancement in solution  
 $a_{ij}$  = sensor sensitivity factors for H-field probes  
 $f$  = carrier frequency [GHz]  
 $E_i$  = electric field strength of channel  $i$  in V/m  
 $H_i$  = magnetic field strength of channel  $i$  in A/m

The RSS value of the field components gives the total field strength (Hermitian magnitude):

$$E_{tot} = \sqrt{E_x^2 + E_y^2 + E_z^2}$$

The primary field data are used to calculate the derived field units.

$$SAR = E_{tot}^2 \cdot \frac{\sigma}{\rho \cdot 1'000}$$

with  $SAR$  = local specific absorption rate in mW/g  
 $E_{tot}$  = total field strength in V/m  
 $\sigma$  = conductivity in [mho/m] or [Siemens/m]  
 $\rho$  = equivalent tissue density in g/cm<sup>3</sup>

Note that the density is normally set to 1 (or 1.06), to account for actual brain density rather than the density of the simulation liquid.

### 3.7. Position of the wireless device in relation to the phantom

#### General considerations

This standard specifies two handset test positions against the head phantom – the “cheek” position and the “tilt” position.

The power flow density is calculated assuming the excitation field as a free space field

$$P_{(pwe)} = \frac{E_{tot}^2}{3770} \text{ or } P_{(pwe)} = H_{tot}^2 \cdot 37.7$$

Where  $P_{pwe}$  = Equivalent power density of a plane wave in mW/cm<sup>2</sup>

$E_{tot}$  = total electric field strength in V/m

$H_{tot}$  = total magnetic field strength in A/m

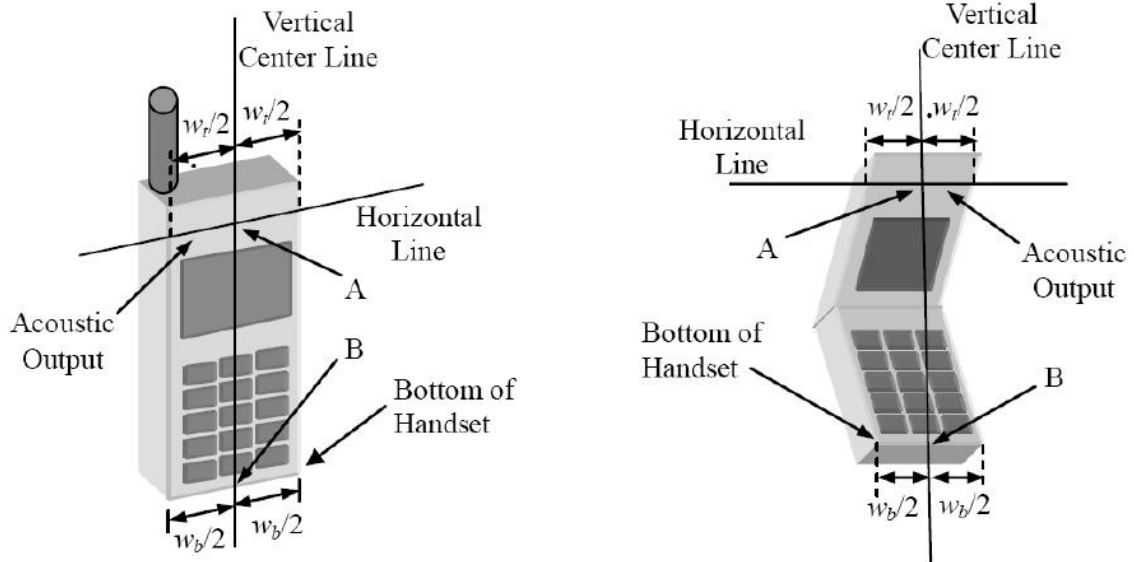

$W_t$  Width of the handset at the level of the acoustic  
 $W_b$  Width of the bottom of the handset  
 A Midpoint of the width  $w_t$  of the handset at the level of the acoustic output  
 B Midpoint of the width  $w_b$  of the bottom of the handset

Picture 1-a Typical "fixed" case handset    Picture 1-b Typical "clam-shell" case handset

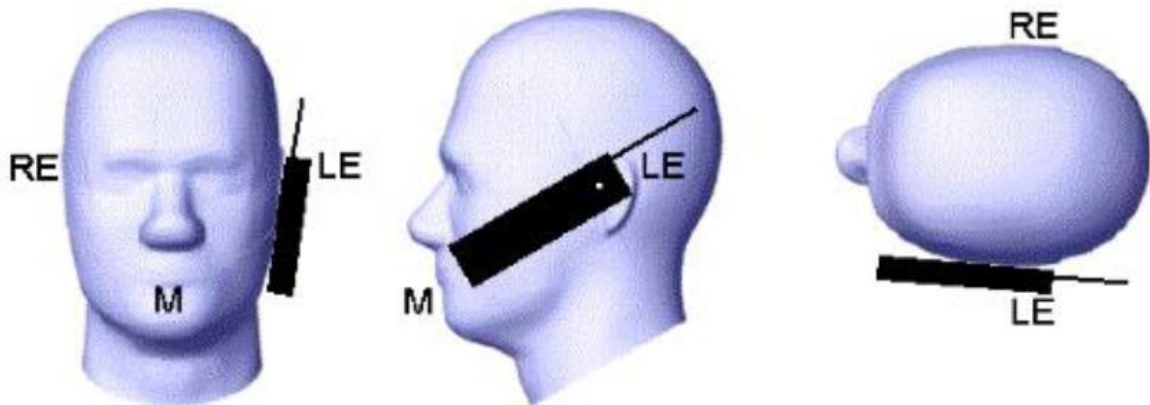

Picture 2 Cheek position of the wireless device on the left side of SAM

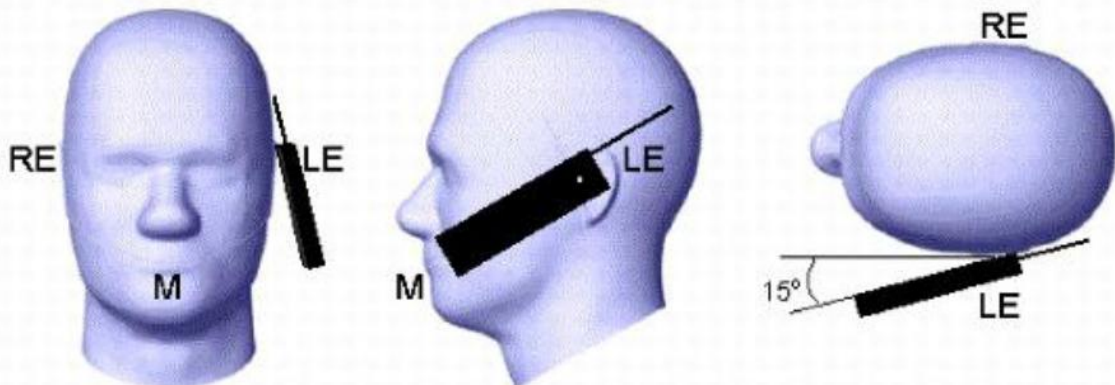

Picture 3 Tilt position of the wireless device on the left side of SAM

### Body-worn device

A typical example of a body-worn device is a Mobile Phone , wireless enabled PDA or other battery operated wireless device with the ability to transmit while mounted on a person's body using a carry accessory approved by the wireless device manufacturer.

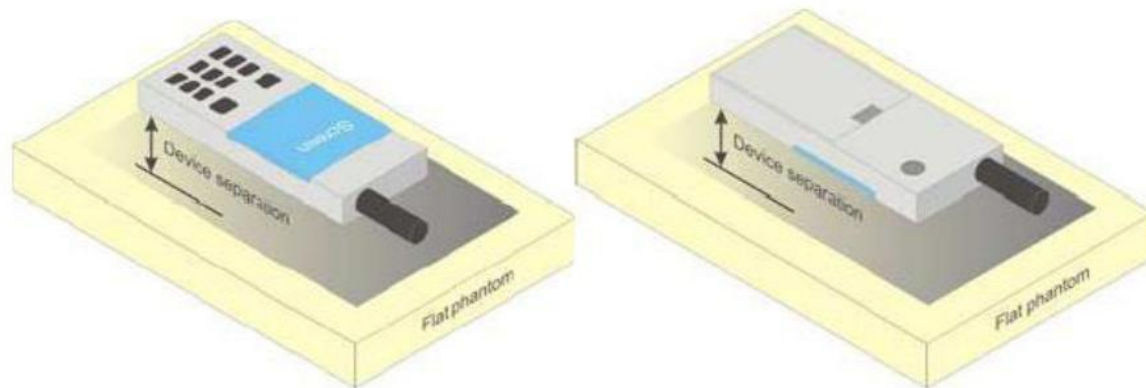

Picture 4 Test positions for body-worn devices

### Devices with hinged or swivel antenna(s)

For devices that employ one or more external antennas with variable positions (e.g. antenna extended, retracted, rotated), these shall be positioned in accordance with the user instructions provided by the manufacturer. For a device with only one antenna, if no intended antenna position is specified, tests shall be performed if applicable in both the horizontal and vertical positions relative to the phantom, and with the antenna oriented away from the body of the DUT (Figure 5) and/or with the antenna extended and retracted such as to obtain the highest exposure condition. For antennas that may be rotated through one or two planes, an evaluation should be made and documented in the measurement report to the highest exposure scenario and only that position(s) need(s) to be tested. For devices with multiple detachable antennas see provisions of 6.2.2.

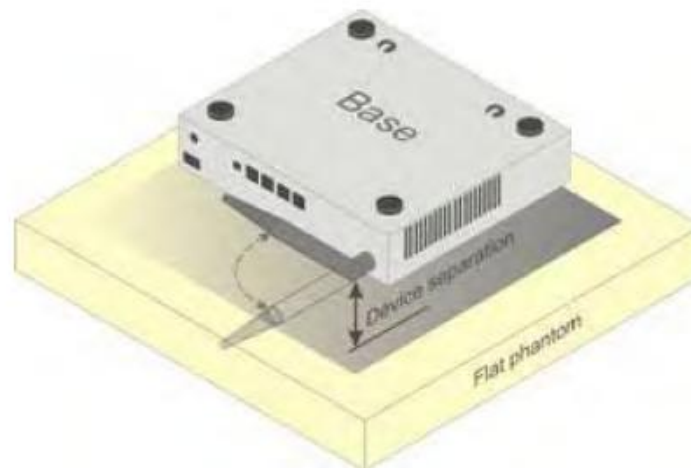

Figure 5– Device with swivel antenna (example of desktop device)

### Body-supported device

A typical example of a body supported device is a wireless enabled laptop device that among other orientations may be supported on the thighs of a sitting user. To represent this orientation, the device shall be positioned with its base against the flat phantom. Other orientations may be specified by the manufacturer in the user instructions. If the intended use is not specified, the device shall be tested directly against the flat phantom in all usable orientations.

The screen portion of the device shall be in an open position at a 90° angle as seen in Figure 6a (left side), or at an operating angle specified for intended use by the manufacturer in the operating instructions. Where a body supported device has an integral screen required for normal operation, then the screen-side will not need to be tested if the antenna(s) integrated in it ordinarily remain(s) 200 mm from the body. Where a screen mounted antenna is present, the measurement shall be performed with the screen against the flat phantom as shown in Figure 6a) (right side), if operating the screen against the body is consistent with the intended use.

Other devices that fall into this category include tablet type portable computers and credit card transaction authorisation terminals, point-of-sale and/or inventory terminals. Where these devices may be torso or limb-supported, the same principles for body-supported devices are applied.

The example in Figure 6b) shows a tablet form factor portable computer for which SAR should be separately assessed with

c). each surface and  
 d). the separation distances  
 positioned against the flat phantom that correspond to the intended use as specified by the manufacturer. If the intended use is not specified in the user instructions, the device shall be tested directly against the flat phantom in all usable orientations.  
 Some body-supported devices may allow testing with an external power supply (e.g. a.c. adapter) supplemental to the battery, but it shall be verified and documented in the measurement report that SAR is still conservative.  
 For devices that employ an external antenna with variable positions (e.g. swivel antenna), see 6.1.4.5 and Figure 5.

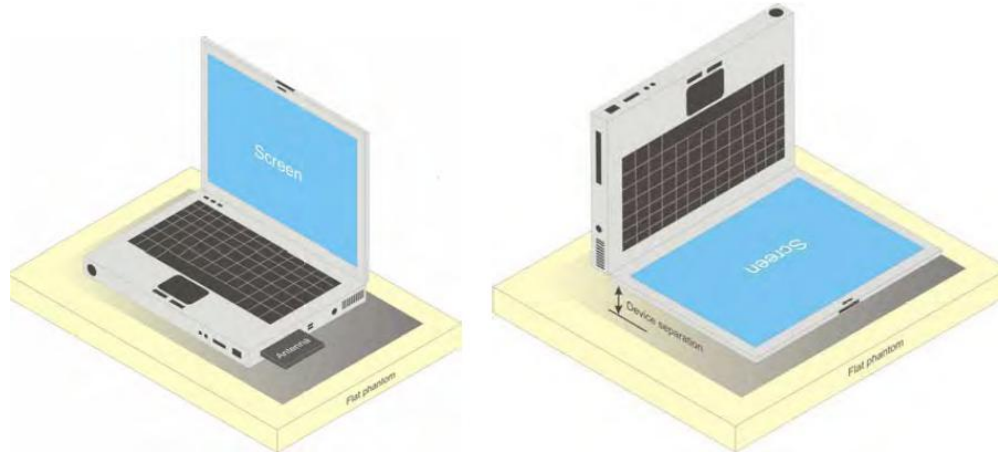

a) Portable computer with external antenna plug-in-radio-card (left side) or with internal antenna located in screen section (right side)

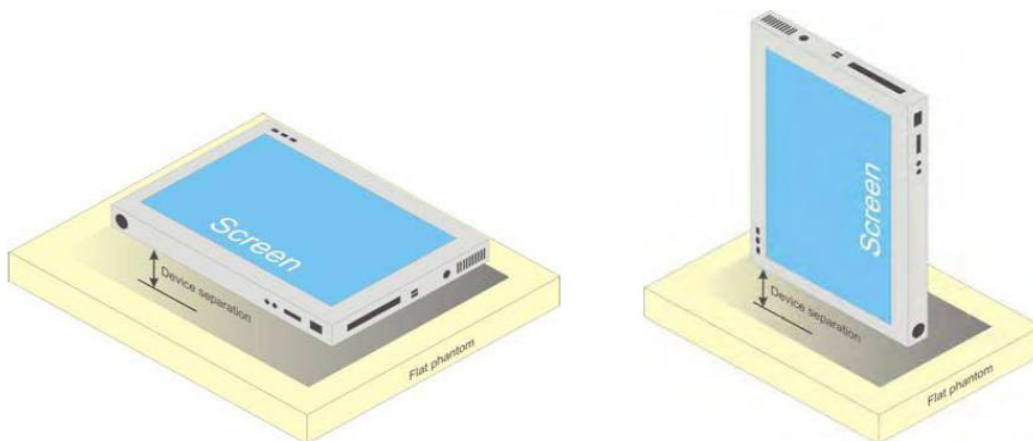

b) Tablet form factor portable computer

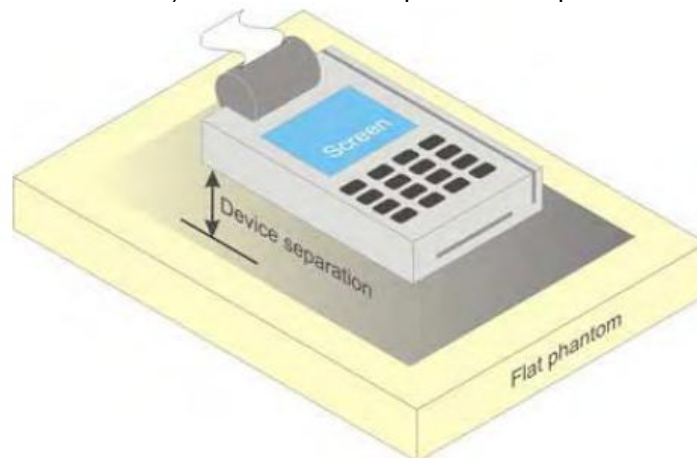

c) Wireless credit card transaction authorisation terminal

Figure 6 – Test positions for body supported devices

**Desktop device**

A typical example of a desktop device is a wireless enabled desktop computer placed on a table or desk when used.

The DUT shall be positioned at the distance and in the orientation to the phantom that corresponds to the intended use as specified by the manufacturer in the user instructions. For devices that employ an external antenna with variable positions, tests shall be performed for all antenna positions specified. Picture 14 shows positions for desktop device SAR tests. If the intended use is not specified, the device shall be tested directly against the flat phantom.

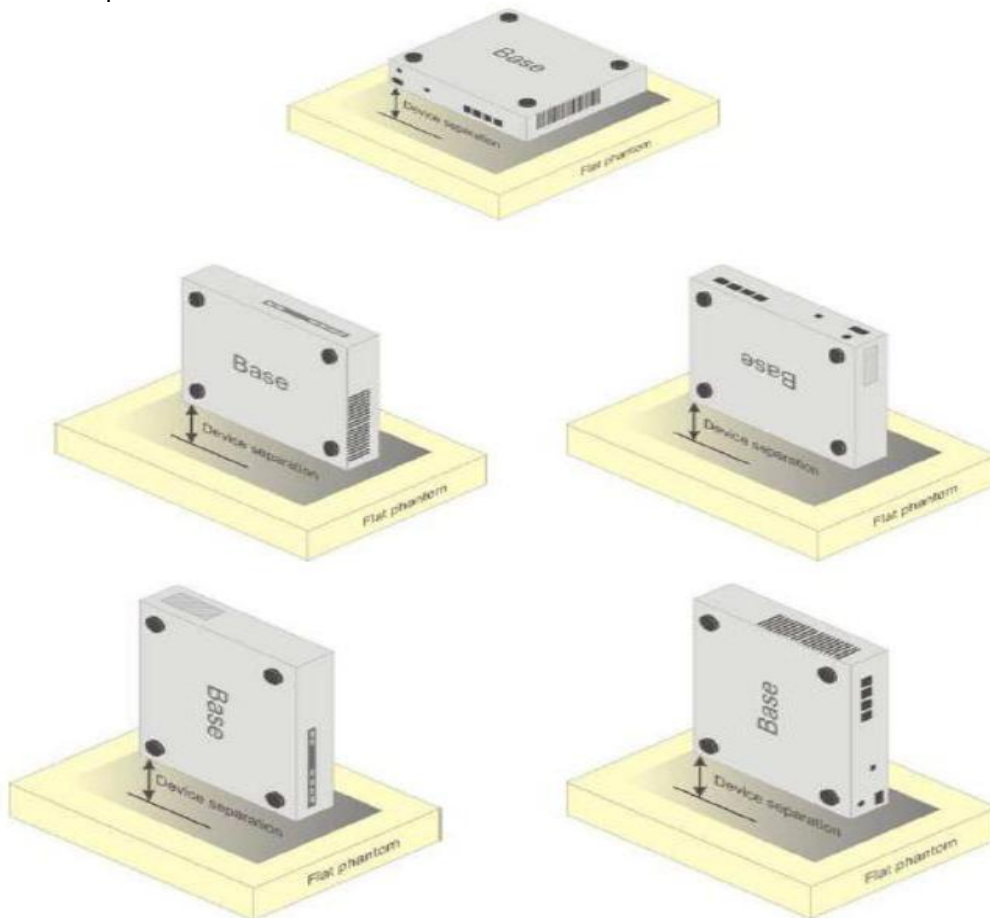

Picture 7 Test positions for desktop devices

**Front-of-face device**

A typical example of a front-of-face device is a two-way radio that is held at a distance from the face of the user when transmitting. In these cases the device under test shall be positioned at the distance to the phantom surface that corresponds to the intended use as specified by the manufacturer in the user instructions (Figure 8a). If the intended use is not specified, a separation distance of 25 mm between the phantom surface and the device shall be used.

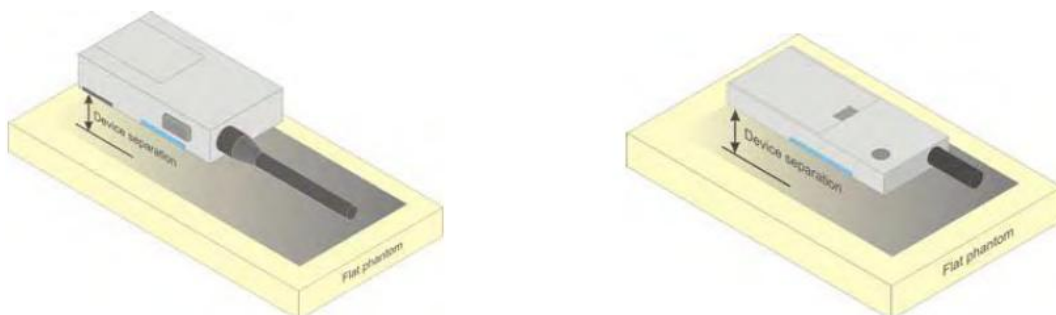

a) Two-way radios

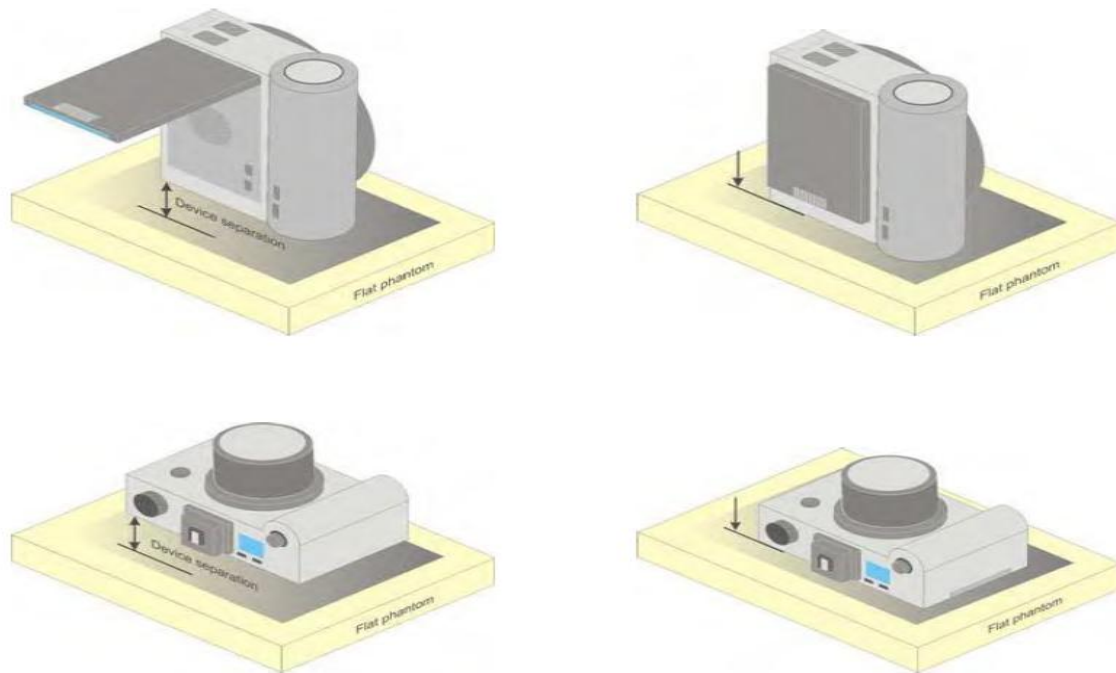

b) Still cameras and video cameras

Figure 8 – Test positions for front-of-face devices

Other devices that fall into this category include wireless-enabled still cameras and video cameras that can send data to a network or other device (Figure 8b). In the case of a device whose intended use requires a separation distance from the user (e.g., device with a viewing screen), this shall be positioned at the distance to the phantom surface that corresponds to the intended use as specified by the manufacturer in the user instructions (Figure 8b, left side). If the intended use is not specified, a separation distance of 25 mm between the phantom surface and the device shall be used.

For a device whose intended use requires the user's face to be in contact with the device (e.g., device with an optical viewfinder), this shall be placed directly against the phantom (Figure 8b, right side).

#### Hand-held usage of the device, not at the head or torso

Additional studies remain needed for devising a representative method for evaluating SAR in the hand of hand-held devices. Future versions of this standard are intended to contain a test method based on scientific data and rationale. Annex J presents the currently available test procedure.

#### Limb-worn device

A limb-worn device is a unit whose intended use includes being strapped to the arm or leg of the user while transmitting (except in idle mode). It is similar to a body-worn device. Therefore, the test positions of 6.1.4.4 also apply. The strap shall be opened so that it is divided into two parts as shown in Figure 9. The device shall be positioned directly against the phantom surface with the strap straightened as much as possible and the back of the device towards the phantom.

If the strap cannot normally be opened to allow placing in direct contact with the phantom surface, it may be necessary to break the strap of the device but ensuring to not damage the antenna.

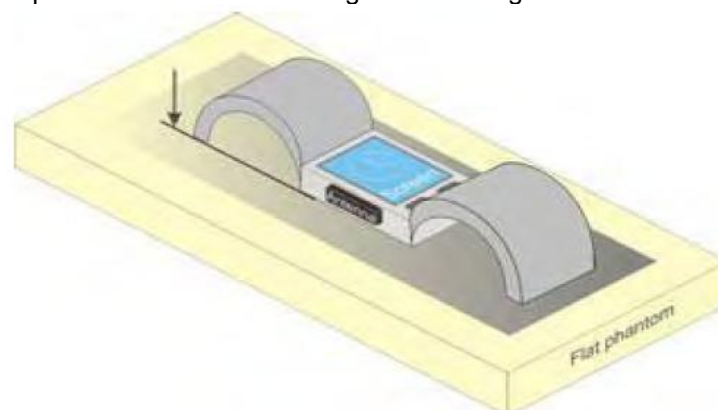

Figure 9 – Test position for limb-worn devices

#### Clothing-integrated device

A typical example of a clothing-integrated device is a wireless device (Mobile Phone ) integrated into a jacket to provide voice communications through an embedded speaker and microphone. This category also includes headgear with integrated wireless devices.

All wireless or RF transmitting components shall be placed in the orientation and at the separation distance to the phantom surface that correspond to intended use of the device when it is integrated into the clothing (Figure 10).

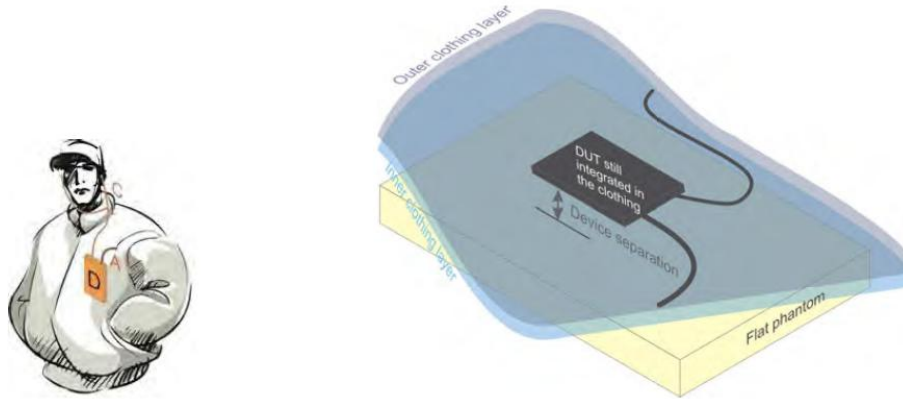

Figure 10– Test position for clothing-integrated wireless devices

### 3.8. Tissue Dielectric Parameters for Head and Body Phantoms

The liquid used for the frequency range of 700-3000 MHz consisted of water, sugar, salt and Cellulose. The liquid has been previously proven to be suited for worst-case. The Table 3 and 4 shows the detail solution. It's satisfying the latest tissue dielectric parameters requirements proposed by the IEEE 1528 and IEC 62209.

Table 2. Composition of the Head Tissue Equivalent Matter

Frequency (MHz)	Bactericide	DGBE	HEC	NaCl	Sucrose	1,2-Propanediol	X100	Water	Conductivity	Permittivity
	%	%	%	%	%	%	%	%	$\sigma$	$\epsilon_r$
750	/	/	/	0.79	/	64.81	/	34.40	0.97	41.8
835	/	/	/	0.79	/	64.81	/	34.40	0.97	41.8
900	/	/	/	0.79	/	64.81	/	34.40	0.97	41.8
1800	/	13.84	/	0.35	/	/	30.45	55.36	1.38	41.0
1900	/	13.84	/	0.35	/	/	30.45	55.36	1.38	41.0
2000	/	7.99	/	0.16	/	/	19.97	71.88	1.55	41.1
2450	/	7.99	/	0.16	/	/	19.97	71.88	1.88	40.3
2600	/	7.99	/	0.16	/	/	19.97	71.88	1.88	40.3

Table 3. Targets for tissue simulating liquid

Frequency (MHz)	Liquid Type	Liquid Type ( $\sigma$ )	$\pm 5\%$ Range	Permittivity ( $\epsilon$ )	$\pm 5\%$ Range
300	Head	0.87	0.83~0.91	45.30	43.04~47.57
450	Head	0.87	0.83~0.91	43.50	41.33~45.68
835	Head	0.90	0.86~0.95	41.50	39.43~43.58
900	Head	0.97	0.92~1.02	41.50	39.43~43.58
1450	Head	1.20	1.14~1.26	40.50	38.48~42.53
1800	Head	1.40	1.33~1.47	40.00	38.00~42.00
1900	Head	1.40	1.33~1.47	40.00	38.00~42.00
1950	Head	1.40	1.33~1.47	40.00	38.00~42.00
2000	Head	1.40	1.33~1.47	40.00	38.00~42.00
2450	Head	1.80	1.71~1.89	39.20	37.24~41.16
3000	Head	2.40	2.28~2.52	38.50	36.58~40.43
300	Body	0.87	0.83~0.91	45.30	43.04~47.57
450	Body	0.87	0.83~0.91	43.50	41.33~45.68
835	Body	0.90	0.86~0.95	41.50	39.43~43.58
900	Body	0.97	0.92~1.02	41.50	39.43~43.58
1450	Body	1.20	1.14~1.26	40.50	38.48~42.53
1800	Body	1.40	1.33~1.47	40.00	38.00~42.00
1900	Body	1.40	1.33~1.47	40.00	38.00~42.00
1950	Body	1.40	1.33~1.47	40.00	38.00~42.00
2000	Body	1.40	1.33~1.47	40.00	38.00~42.00
2100	Body	1.49	1.42~1.56	39.80	37.81~41.79
2450	Body	1.80	1.71~1.89	39.20	37.24~41.16
2600	Body	1.96	1.86~2.06	39.00	37.05~40.95
3000	Body	2.40	2.28~2.52	38.50	36.58~40.43
3500	Body	2.91	2.77~3.06	37.90	36.01~39.80
4000	Body	3.43	3.26~3.61	37.40	35.53~39.27
4500	Body	3.94	3.74~4.14	36.80	34.96~38.64
5000	Body	4.45	4.23~4.67	36.20	34.39~38.01
5200	Body	4.66	4.43~4.89	36.00	34.20~37.80
5400	Body	4.86	4.62~5.10	35.80	34.01~37.59
5600	Body	5.07	4.82~5.32	35.50	33.73~37.28
5800	Body	5.27	5.01~5.53	35.30	33.54~37.07
6000	Body	5.48	5.21~5.75	35.10	33.35~36.86



### 3.9. Test Condition and Dielectric Performance

Test Condition and Test Date

Test Engineer: Ping Li			
Liquid Frequency	Measurement temperature	Measurement humidity	Measurement Date
900 MHz	23.2°C	52.1%	April 26, 2021
1800 MHz	24.0°C	52.1%	April 30, 2021
2000 MHz	23.1°C	53.4%	May 12, 2021
2450 MHz	23.2°C	54.3%	May 24, 2021
2600 MHz	21.4°C	54.5%	May 30, 2021
5000-6000MHz	22.2°C	52.0%	June 15, 2021

Dielectric Performance of Head Tissue Simulating Liquid

Measured Frequency (MHz)	Target Tissue		Measured Tissue			
	$\sigma$	$\epsilon_r$	$\sigma$	Dev.	$\epsilon_r$	Dev.
900	0.97	41.5	0.94	-3.09%	42.58	2.60%
1800	1.40	40.0	1.43	2.14%	40.64	1.60%
2000	1.40	40.0	1.42	1.43%	39.17	-2.08%
2450	1.80	39.2	1.78	-1.11%	38.35	-2.17%
2600	1.96	39.0	1.90	-3.06%	40.35	3.46%
5000-6000	4.66	36.0	4.59	-1.50%	35.81	-0.53%

### 3.10. System Check

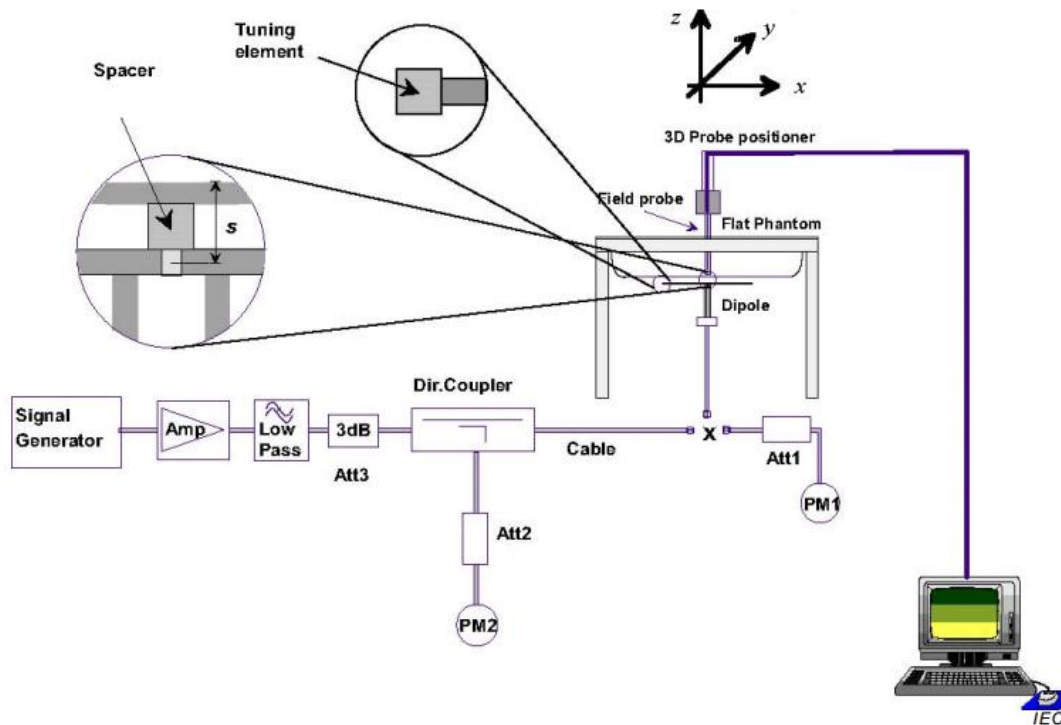

Figure D.1 – Test set-up for the system check

The system performance check verifies that the system operates within its specifications. System and operator errors can be detected and corrected. It is recommended that the system performance check be performed prior to any usage of the system in order to guarantee reproducible results. The system performance check uses normal SAR measurements in a simplified setup with a well characterized source. This setup was selected to give a high sensitivity to all parameters that might fail or vary over time. The system check does not intend to replace the calibration of the components, but indicates situations where the system uncertainty is exceeded due to drift or failure.

In the simplified setup for system evaluation, the DUT is replaced by a calibrated dipole and the power source is replaced by a continuous wave that comes from a signal generator. The calibrated dipole must be placed beneath the flat phantom section of the SAM twin phantom with the correct distance holder. The distance holder should touch the phantom surface with a light pressure at the reference marking and be oriented parallel to the long side of the phantom. The equipment setup is shown below:

- 1 Signal Generator
- 2 Amplifier
- 3 Directional Coupler
- 4 Power Meter
- 5 Calibrated Dipole

The output power on dipole port must be calibrated to 20 dBm (100 mW) before dipole is connected.



Photo of Dipole Setup

#### System Validation of Head

Verification results	Frequency (MHz)	Target value (W/kg)		Measured value (W/kg)		Deviation	
		1 g Average	10 g Average	1 g Average	10 g Average	1 g Average	10 g Average
		900	10.9	6.99	11.4	7.21	4.59%
1800	38.4	20.1	40.1	18.9	4.43%	-5.97%	
2000	41.1	21.1	40.5	19.6	-1.46%	-7.11%	
2450	52.4	24.0	49.8	23.4	-4.96%	-2.50%	
2600	55.3	24.6	56.1	24.5	1.45%	-0.41%	
5000	76.5	21.6	76.3	21.0	-0.26%	-2.78%	

### 3.11. Measurement Procedures

#### Tests to be performed

In order to determine the highest value of the peak spatial-average SAR of a handset, all device positions, configurations and operational modes shall be tested for each frequency band according to steps 1 to 3 below. A flowchart of the test process is shown in Picture 11

Step 1: The tests described in 11.2 shall be performed at the channel that is closest to the centre of the transmit frequency band ( $f_c$ ) for:

- a) all device positions (cheek and tilt, for both left and right sides of the SAM phantom, as described in Chapter 8),
- b) all configurations for each device position in a), e.g., antenna extended and retracted, and
- c) all operational modes, e.g., analogue and digital, for each device position in a) and configuration in b) in each frequency band.

d) If more than three frequencies need to be tested according to 11.1 (i.e.,  $N_c > 3$ ), then all frequencies, configurations and modes shall be tested for all of the above test conditions.

Step 2: For the condition providing highest peak spatial-average SAR determined in Step 1, perform all tests described in 11.2 at all other test frequencies, i.e., lowest and highest frequencies. In addition, for all other conditions (device position, configuration and operational mode) where the peak spatial-average SAR value determined in Step 1 is within 3 dB of the applicable SAR limit, it is recommended that all other test frequencies shall be tested as well.

Step 3: Examine all data to determine the highest value of the peak spatial-average SAR found in Steps 1 to 2.

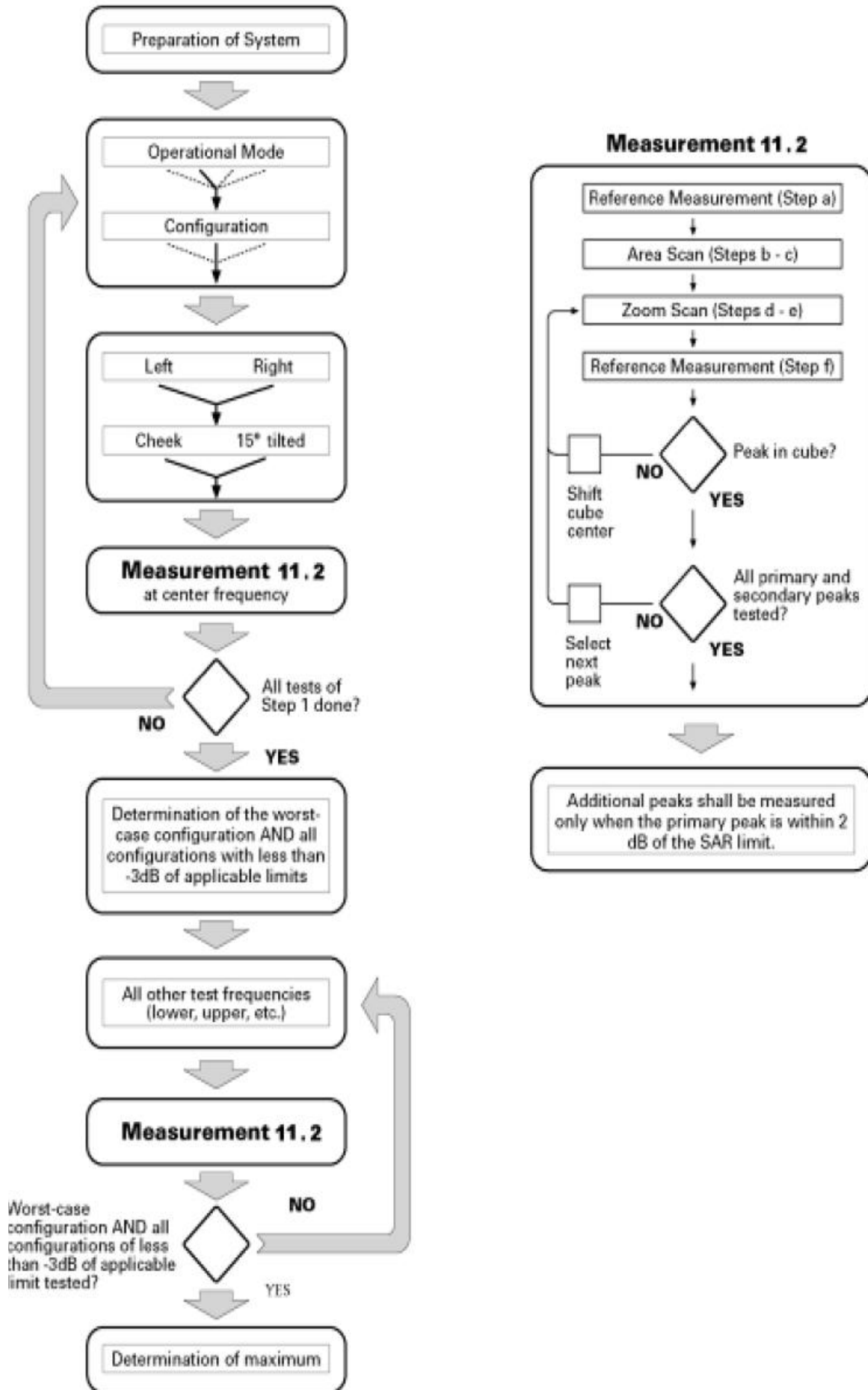

Picture 11 Block diagram of the tests to be performed

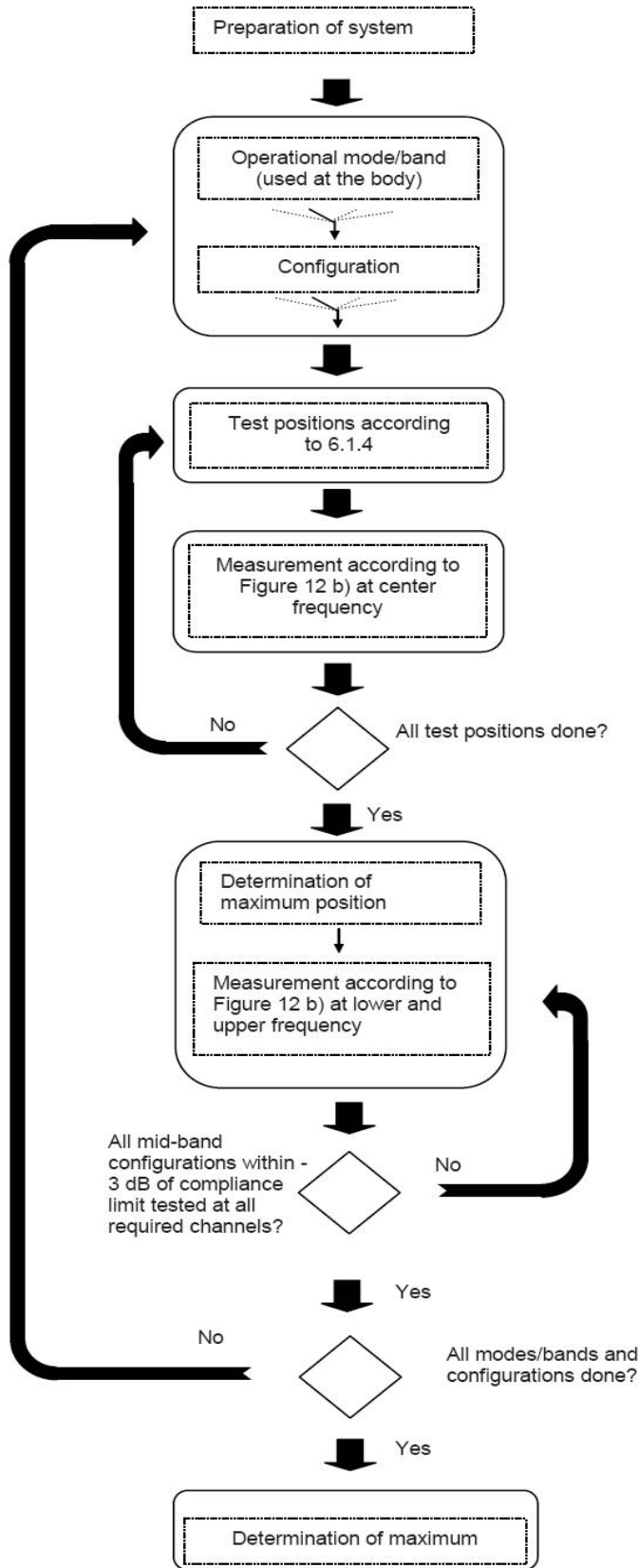

Figure 12a – Tests to be performed

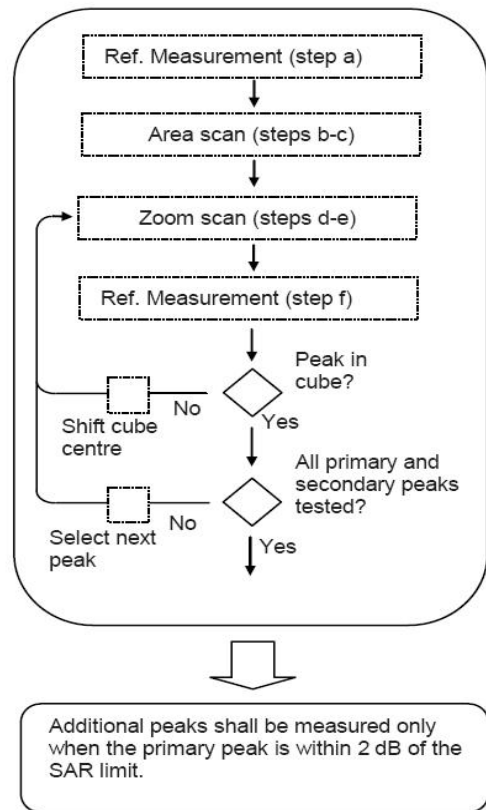

Figure 12b – General procedure

Picture 12 Block diagram of the tests to be performed

**Measurement procedure**

The following procedure shall be performed for each of the test conditions (see Picture 11) described in 11.1:

- a) Measure the local SAR at a test point within 4 mm or less in the normal direction from the inner surface of the phantom.
- b) Measure the two-dimensional SAR distribution within the phantom (area scan procedure). The boundary of the measurement area shall not be closer than 20 mm from the phantom side walls. The distance between the measurement points should enable the detection of the location of local maximum with an accuracy of better than half the linear dimension of the tissue cube after interpolation. A maximum grid spacing of 20 mm for frequencies below 3 GHz and  $(60/f \text{ [GHz]})$  mm for frequencies of 3 GHz and greater is recommended. The maximum distance between the geometrical centre of the probe detectors and the inner surface of the phantom shall be 5 mm for frequencies below 3 GHz and  $\delta \ln(2)/2$  mm for frequencies of 3 GHz and greater, where  $\delta$  is the plane wave skin depth and  $\ln(x)$  is the natural logarithm. The maximum variation of the sensor-phantom surface shall be  $\pm 1$  mm for frequencies below 3 GHz and  $\pm 0.5$  mm for frequencies of 3 GHz and greater. At all measurement points the angle of the probe with respect to the line normal to the surface should be less than  $5^\circ$ . If this cannot be achieved for a measurement distance to the phantom inner surface shorter than the probe diameter, additional measurement distance to the phantom inner surface shorter than the probe diameter, additional
- c) From the scanned SAR distribution, identify the position of the maximum SAR value, in addition identify the positions of any local maxima with SAR values within 2 dB of the maximum value that are not within the zoom-scan volume; additional peaks shall be measured only when the primary peak is within 2 dB of the SAR limit. This is consistent with the 2 dB threshold already stated;
- d) Measure the three-dimensional SAR distribution at the local maxima locations identified in step
- e) The horizontal grid step shall be  $(24 / f \text{ [GHz]})$  mm or less but not more than 8 mm. The minimum zoom size of 30 mm by 30 mm and 30 mm for frequencies below 3 GHz. For higher frequencies, the minimum zoom size of 22 mm by 22 mm and 22 mm. The grid step in the vertical direction shall be  $(8 - f \text{ [GHz]})$  mm or less but not more than 5 mm, if uniform spacing is used. If variable spacing is used in the vertical direction, the maximum spacing between the two closest measured points to the phantom shell shall be  $(12 / f \text{ [GHz]})$  mm or less but not more than 4 mm, and the spacing between father points shall increase by an incremental factor not exceeding 1.5. When variable spacing is used, extrapolation routines shall be tested with the same spacing as used in measurements. The maximum distance between the geometrical centre of the probe detectors and the inner surface of the phantom shall be 5 mm for frequencies below 3 GHz and  $\delta \ln(2)/2$  mm for frequencies of 3 GHz and greater, where  $\delta$  is the plane wave skin depth and  $\ln(x)$  is the natural logarithm. Separate grids shall be centered on each of the local SAR maxima found in step c). Uncertainties due to field distortion between the media boundary and the dielectric enclosure of the probe should also be minimized, which is achieved is the distance between the phantom surface and physical tip of the probe is larger than probe tip diameter. Other methods may utilize correction procedures for these boundary effects that enable high precision measurements closer than half the probe diameter. For all measurement points, the angle of the probe with respect to the flat phantom surface shall be less than  $5^\circ$ . If this cannot be achieved an additional uncertainty evaluation is needed.
- f) Use post processing ( e.g. interpolation and extrapolation ) procedures to determine the local SAR values at the spatial resolution needed for mass averaging.

**WCDMA Measurement Procedures for SAR**

The following procedures are applicable to WCDMA handsets operating under 3GPP Release 99, Release 5 and Release 6. The default test configuration is to measure SAR with an established radio link between the DUT and a communication test set using a 12.2 kbps RMC (reference measurement channel) configured in Test Loop Mode 1. SAR is selectively confirmed for other physical channel configurations (DPCCCH & DPDCH), HSDPA and HSPA (HSUPA/HSDPA) modes according to output power, exposure conditions and device operating capabilities. Both uplink and downlink should be configured with the same RMC or AMR, when required. SAR for Release 5 HSDPA and Release 6 HSPA are measured using the applicable FRC (fixed reference channel) and E-DCH reference channel configurations. Maximum output power is verified according to applicable versions of 3GPP TS 34.121 and SAR must be measured according to these maximum output conditions. When Maximum Power Reduction (MPR) is not implemented according to Cubic Metric (CM) requirements for Release 6 HSPA, the following procedures do not apply.

**For Release 5 HSDPA Data Devices:**

Sub-test	$\beta_c$	$\beta_d$	$\beta_d$ (SF)	$\beta_c / \beta_d$	$\beta_{hs}$	CM/dB
1	2/15	15/15	64	2/15	4/15	0.0
2	12/15	15/15	64	12/15	24/25	1.0
3	15/15	8/15	64	15/8	30/15	1.5
4	15/15	4/15	64	15/4	30/15	1.5

**For Release 6 HSUPA Data Devices**

Sub-test	$\beta_c$	$\beta_d$	$\beta_d$ (SF)	$\beta_c / \beta_d$	$\beta_{hs}$	$\beta_{ec}$	$\beta_{ed}$	$\beta_{ed}$ (SF)	$\beta_{ed}$ (codes)	CM (dB)	MPR (dB)	AG Index	E-TFCI
1	11/15	15/15	64	11/15	22/15	209/225	1039/225	4	1	1.0	0.0	20	75
2	6/15	15/15	64	6/15	12/15	12/15	12/15	4	1	3.0	2.0	12	67
3	15/15	9/15	64	15/9	30/15	30/15	$\beta_{ed1}:47/15$ $\beta_{ed2}:47/15$	4	2	2.0	1.0	15	92
4	2/15	15/15	64	2/15	4/15	4/15	56/75	4	1	3.0	2.0	17	71
5	15/15	15/15	64	15/15	24/15	30/15	134/15	4	1	1.0	0.0	21	81

## 4. TEST CONDITIONS AND RESULTS

### 4.1. Conducted Power Results

During the process of testing, the EUT was controlled via Rhode & Schwarz Digital Radio Communication tester (CMW500) to ensure the maximum power transmission and proper modulation. This result contains conducted output power for the EUT. In all cases, the measured peak output power should be greater and within 5% than EMI measurement.

The conducted power measurement results for GSM900/DCS1800

GSM900	Conducted Power (dBm)		
	Channel 124 (914.80MHz)	Channel 63 (902.60MHz)	Channel 975 (880.20MHz)
	32.56	32.58	32.67
DCS1800	Conducted Power (dBm)		
	Channel 885 (1784.80MHz)	Channel 698 (1747.40MHz)	Channel 512 (1710.20MHz)
	29.74	29.71	29.57

The conducted power measurement results for GPRS

GPRS 900 (GMSK)	Measured Power (dBm)			Calculation (dB)	Averaged Power (dBm)		
	880.2 MHz	902.6 MHz	914.8 MHz		880.2 MHz	902.6 MHz	914.8 MHz
1 Txslot	31.02	31.05	31.11	-9.03	21.99	22.02	22.08
2 Txslot	28.53	28.43	28.53	-6.02	22.51	22.41	22.51
3 Txslot	26.19	26.18	26.24	-4.26	21.93	21.92	21.98
<b>4 Txslot</b>	<b>25.40</b>	<b>25.52</b>	<b>25.54</b>	<b>-3.01</b>	<b>22.39</b>	<b>22.51</b>	<b>22.53</b>
GPRS 1800 (GMSK)	Measured Power (dBm)			Calculation (dB)	Averaged Power (dBm)		
	1710.2 MHz	1747.4 MHz	1784.8 MHz		1710.2 MHz	1747.4 MHz	1784.8 MHz
1 Txslot	28.27	28.33	28.34	-9.03	19.24	19.30	19.31
<b>2 Txslot</b>	<b>26.33</b>	<b>26.28</b>	<b>26.37</b>	<b>-6.02</b>	<b>20.31</b>	<b>20.26</b>	<b>20.35</b>
3 Txslot	23.64	23.55	23.72	-4.26	19.38	19.29	19.46
4 Txslot	21.09	21.01	21.07	-3.01	18.08	18.00	18.06

The conducted power measurement results for EGPRS

GPRS 900 (GMSK)	Measured Power (dBm)			Calculation (dB)	Averaged Power (dBm)		
	880.2 MHz	902.6 MHz	914.8 MHz		880.2 MHz	902.6 MHz	914.8 MHz
1 Txslot	26.25	26.19	26.14	-9.03	17.22	17.16	17.11
<b>2 Txslot</b>	<b>25.51</b>	<b>25.51</b>	<b>25.57</b>	<b>-6.02</b>	<b>19.49</b>	<b>19.49</b>	<b>19.55</b>
3 Txslot	22.51	22.44	22.43	-4.26	18.25	18.18	18.17
4 Txslot	20.89	20.84	20.72	-3.01	17.88	17.83	17.71
GPRS 1800 (GMSK)	Measured Power (dBm)			Calculation (dB)	Averaged Power (dBm)		
	1710.2 MHz	1747.4 MHz	1784.8 MHz		1710.2 MHz	1747.4 MHz	1784.8 MHz
1 Txslot	26.21	26.31	26.34	-9.03	17.18	17.28	17.31
<b>2 Txslot</b>	<b>23.59</b>	<b>23.55</b>	<b>23.56</b>	<b>-6.02</b>	<b>17.57</b>	<b>17.53</b>	<b>17.54</b>
3 Txslot	20.96	20.93	21.08	-4.26	16.70	16.67	16.82
4 Txslot	20.44	20.54	20.55	-3.01	17.43	17.53	17.54

**Note:**

1. Division Factors

To average the power, the division factor is as follows:

1TX-slot = 1 transmit time slot out of 8 time slots=> conducted power divided by (8/1) => -9.03dB

2TX-slots = 2 transmit time slots out of 8 time slots=> conducted power divided by (8/2) => -6.02dB

3TX-slots = 3 transmit time slots out of 8 time slots=> conducted power divided by (8/3) => -4.26dB

4TX-slots = 4 transmit time slots out of 8 time slots=> conducted power divided by (8/4) => -3.01dB

2. According to the conducted power as above, the body measurements are performed with 4Txslots for 900MHz and 2Txslots for 1800MHz for GPRS.



**The conducted power measurement results for WCDMA**

Item	band	FDD Band VIII result (dBm)			FDD Band I result (dBm)		
		Test Channel			Test Channel		
	sub-test	2712	2788	2836	9613	9750	9887
5.2(WCDMA)	\	23.21	23.17	23.16	23.26	23.29	23.29
5.2AA (HSDPA)	1	22.32	22.33	22.35	22.32	22.31	22.29
	2	22.08	22.10	22.31	22.21	21.98	22.02
	3	21.84	21.92	22.11	22.06	21.72	21.87
	4	21.72	21.83	21.94	21.92	21.69	21.53
5.2B (HSUPA)	1	22.26	22.32	22.33	22.31	22.34	22.33
	2	22.03	22.17	22.22	22.36	22.05	22.28
	3	21.78	22.26	22.23	22.32	21.96	22.36
	4	21.67	22.04	22.05	22.39	21.96	22.13
	5	21.52	21.86	22.09	22.17	21.86	22.10

**The conducted power measurement results for WLAN**

Mode	Channel	Frequency (MHz)	Conducted Output Power	Test Rate Data
			(dBm)	
802.11b	1	2412	13.23	1 Mbps
	7	2442	13.58	1 Mbps
	13	2472	13.30	1 Mbps
802.11g	1	2412	13.48	6 Mbps
	7	2442	13.69	6 Mbps
	13	2472	13.81	6 Mbps
802.11n(20MHz)	1	2412	13.45	6.5 Mbps
	7	2442	13.88	6.5 Mbps
	13	2472	13.58	6.5 Mbps
802.11n(40MHz)	3	2422	13.86	13 Mbps
	7	2442	13.31	13 Mbps
	11	2462	13.01	13 Mbps

**The conducted power measurement results for WLAN 5.2G**

Mode	Channel	Frequency (MHz)	Conducted Output Power(dBm)
802.11a	36	5180	12.41
	40	5200	12.36
	48	5240	12.82
802.11n(20MHz)	36	5180	12.40
	40	5200	12.31
	48	5240	12.60
802.11n(40MHz)	38	5190	12.61
	46	5230	12.13

**The conducted power measurement results for 5.8G SRD**

Mode	Channel	Frequency (MHz)	Conducted Output Power(dBm)
802.11a	149	5745	12.13
	157	5785	12.09
	165	5825	12.18
802.11n(20MHz)	149	5745	10.89
	157	5785	10.79
	165	5825	10.68
802.11n(40MHz)	151	5755	10.36
	159	5795	10.29

**The conducted power measurement results for BluetoothV5.0**

Mode	Channel	Frequency (MHz)	Conducted Output Power
			(dBm)
BLE	00	2402	-1.76
	19	2440	-2.95
	39	2480	-4.21
GFSK	00	2402	2.94
	39	2441	2.87
	78	2480	3.08
$\pi/4$ -DQPSK	00	2402	1.89
	39	2441	1.86
	78	2480	2.15
8DPSK	00	2402	2.08
	39	2441	1.75
	78	2480	1.97

**Note:** 1. because the output power (EIRP) of Bluetooth of the EUT is less than 20mW (13dBm), so standalone SAR are exempt according EN50663.

**The conducted power measurement results for LTE****LTE-BAND1**

Channel Bandwidth	Channel	RB allocation		Average Power (dBm) QPSK	Average Power (dBm) 16-QAM
		RB Size	RB Offset		
5MHz	Low range	1	0	22.85	22.23
			max	22.78	22.13
		Partial	0	22.61	21.96
			max	22.73	22.01
	Mid range	1	0	22.23	21.50
			max	21.49	20.78
		Partial	0	21.83	21.14
			max	21.74	21.07
	High range	1	0	23.20	22.50
			max	22.48	21.70
		Partial	0	23.23	22.49
			max	22.09	21.35
20MHz	Low range	1	0	21.81	21.12
			max	22.80	22.08
		Partial	0	21.95	21.19
			max	22.42	21.73
	Mid range	1	0	22.46	21.70
			max	21.24	20.52
		Partial	0	21.70	20.98
			max	21.70	21.06
	High range	1	0	21.22	20.57
			max	21.66	20.90
		Partial	0	21.39	20.66
			max	21.70	21.06

**LTE-BAND3**

Channel Bandwidth	Channel	RB allocation		Average Power (dBm) QPSK	Average Power (dBm) 16-QAM
		RB Size	RB Offset		
1.4MHz	Low range	1	0	22.15	21.41
			max	21.95	21.23
		Partial	0	21.92	21.26
			max	22.16	21.38
	Mid range	1	0	22.73	22.07
			max	22.81	22.08
		Partial	0	22.74	22.04
			max	22.85	22.10
	High range	1	0	21.94	21.20
			max	21.95	21.25
		Partial	0	21.63	20.92
			max	21.98	21.26
5 MHz	Low range	1	0	22.19	21.45
			max	21.50	20.86
		Partial	0	21.91	21.12
			max	21.62	20.88
	Mid range	1	0	22.70	22.07
			max	22.43	21.70
		Partial	0	22.77	22.11
			max	22.44	21.77
	High range	1	0	21.91	21.22
			max	21.75	21.05
		Partial	0	21.80	21.14
			max	21.85	21.15
20MHz	Low range	1	0	21.72	21.03
			max	21.54	20.88
		Partial	0	21.78	21.05
			max	21.35	20.71
	Mid range	1	0	22.58	21.90
			max	22.66	21.96
		Partial	0	22.91	22.15
			max	22.56	21.92
	High range	1	0	22.51	21.88
			max	21.49	20.78
		Partial	0	22.51	21.78
			max	21.69	21.06

**LTE-BAND7**

Channel Bandwidth	Channel	RB allocation		Average Power (dBm) QPSK	Average Power (dBm) 16-QAM
		RB Size	RB Offset		
5 MHz	Low range	1	0	22.86	22.17
			max	22.30	21.61
		Partial	0	22.70	22.07
			max	22.38	21.72
	Mid range	1	0	21.28	20.61
			max	21.45	20.71
		Partial	0	21.21	20.55
			max	21.48	20.88
	High range	1	0	21.59	20.91
			max	22.27	21.55
		Partial	0	22.31	21.58
			max	22.35	21.66
20MHz	Low range	1	0	22.68	21.99
			max	22.69	21.97
		Partial	0	22.69	21.94
			max	22.27	21.54
	Mid range	1	0	21.38	20.68
			max	23.52	22.81
		Partial	0	21.70	20.99
			max	23.39	22.64
	High range	1	0	23.88	23.18
			max	21.26	20.54
		Partial	0	23.81	23.09
			max	23.48	22.75

**LTE-BAND8**

Channel Bandwidth	Channel	RB allocation		Average Power (dBm) QPSK	Average Power (dBm) 16-QAM
		RB Size	RB Offset		
1.4MHz	Low range	1	0	22.74	22.14
			max	22.85	22.22
		Partial	0	23.04	22.36
			max	22.88	22.16
	Mid range	1	0	22.62	21.97
			max	22.90	22.18
		Partial	0	22.70	21.97
			max	22.60	21.89
	High range	1	0	23.15	22.41
			max	23.17	22.49
		Partial	0	23.17	22.54
			max	23.22	22.54
5MHz	Low range	1	0	23.14	22.43
			max	22.94	22.27
		Partial	0	23.07	22.35
			max	22.74	21.98
	Mid range	1	0	22.38	21.63
			max	22.63	21.86
		Partial	0	22.52	21.77
			max	22.76	22.04
	High range	1	0	23.17	22.45
			max	22.94	22.22
		Partial	0	23.08	22.37
			max	23.18	22.51
20MHz	Low range	1	0	23.06	22.37
			max	22.85	22.09
		Partial	0	22.32	21.65
			max	22.85	22.16
	Mid range	1	0	22.24	21.56
			max	22.53	21.83
		Partial	0	22.78	22.07
			max	22.57	21.92
	High range	1	0	22.55	21.89
			max	23.24	22.48
		Partial	0	22.95	22.32
			max	23.35	22.71

**LTE-BAND20**

Channel Bandwidth	Channel	RB allocation		Average Power (dBm) QPSK	Average Power (dBm) 16-QAM
		RB Size	RB Offset		
5MHz	Low range	1	0	22.52	21.78
			max	22.54	21.90
		Partial	0	22.65	21.88
			max	22.71	21.99
	Mid range	1	0	22.69	21.95
			max	22.63	21.99
		Partial	0	22.74	22.07
			max	22.76	22.05
	High range	1	0	22.74	22.07
			max	22.65	21.92
		Partial	0	22.71	22.05
			max	22.74	22.02
20MHz	Low range	1	0	22.64	21.95
			max	22.57	21.88
		Partial	0	22.59	21.86
			max	22.72	22.03
	Mid range	1	0	22.61	21.85
			max	22.66	21.95
		Partial	0	22.86	22.15
			max	22.72	22.00
	High range	1	0	22.50	21.80
			max	22.63	21.87
		Partial	0	22.72	22.03
			max	22.74	22.01

**LTE-BAND38**

Channel Bandwidth	Channel	RB allocation		Average Power (dBm) QPSK	Average Power (dBm) 16-QAM
		RB Size	RB Offset		
5MHz	Low range	1	0	23.09	22.46
			max	23.12	22.46
		Partial	0	23.07	22.43
			max	23.21	22.44
	Mid range	1	0	23.08	22.42
			max	23.05	22.33
		Partial	0	23.11	22.37
			max	23.27	22.54
	High range	1	0	23.00	22.31
			max	23.14	22.41
		Partial	0	23.04	22.33
			max	23.12	22.42
20MHz	Low range	1	0	23.01	22.37
			max	23.15	22.50
		Partial	0	23.05	22.36
			max	23.03	22.36
	Mid range	1	0	23.31	22.62
			max	23.18	22.41
		Partial	0	23.04	22.29
			max	23.26	22.54
	High range	1	0	22.92	22.22
			max	22.99	22.28
		Partial	0	23.12	22.40
			max	23.07	22.37



**LTE-BAND40**

Channel Bandwidth	Channel	RB allocation		Average Power (dBm) QPSK	Average Power (dBm) 16-QAM
		RB Size	RB Offset		
5MHz	Low range	1	0	23.87	23.11
			max	22.29	21.52
		Partial	0	23.67	22.94
			max	22.41	21.76
	Mid range	1	0	22.98	22.26
			max	21.60	20.93
		Partial	0	23.19	22.52
			max	21.60	20.92
	High range	1	0	23.75	23.03
			max	21.99	21.33
		Partial	0	23.75	23.04
			max	22.24	21.47
20MHz	Low range	1	0	23.67	22.98
			max	22.24	21.60
		Partial	0	23.83	23.12
			max	22.39	21.61
	Mid range	1	0	23.08	22.36
			max	21.49	20.76
		Partial	0	23.14	22.47
			max	21.98	21.27
	High range	1	0	23.67	22.97
			max	22.01	21.30
		Partial	0	23.96	23.27
			max	22.68	22.00

## 4.2. Test reduction procedure

### Maximum power level

The maximum power level,  $P_{\max,m}$ , that can be transmitted by a device before the SAR averaged over a mass,  $m$ , exceeds a given limit,  $SAR_{\lim}$ , can be defined. Any device transmitting at power levels below  $P_{\max,m}$  can then be excluded from SAR testing. The lowest possible value for  $P_{\max,m}$  is:  $P_{\max,m} = SAR_{\lim} \cdot m$ .

When working alone, the averages transmit power of BT module should be less than 20mW. According to the test results, when working alone, the testing of BT module is not necessary.

### Simultaneous Multi-band Transmission SAR Analysis List of Mode for Simultaneous Multi-band

#### Transmission

No.	Configurations	Head SAR	Body SAR
1	GSM + 2.4G WLAN	Yes	Yes
2	WCDMA +2.4G WLAN	Yes	Yes
3	LTE +2.4G WLAN	Yes	Yes
4	GSM + 5.2G WLAN	Yes	Yes
5	WCDMA +5.2G WLAN	Yes	Yes
6	LTE +5.2G WLAN	Yes	Yes
7	GSM + 5.8G WLAN	Yes	Yes
8	WCDMA +5.8G WLAN	Yes	Yes
9	LTE +5.8G WLAN	Yes	Yes
10	GSM + Bluetooth	Yes	Yes
11	WCDMA + Bluetooth	Yes	Yes
12	LTE + Bluetooth	Yes	Yes

#### Remark:

One way of determining the threshold power level available to the secondary transmitter ( $P_{\text{available}}$ ) is to calculate it from the measured peak spatial-average SAR of the primary transmitter ( $SAR_1$ ) according to the equation:

$$P_{\text{available}} = P_{\text{th},m} \times (SAR_{\lim} - SAR_1) / SAR_{\lim}$$

where  $P_{\text{th},m}$  is the threshold exclusion power level taken from Annex B of EN 50663 for the frequency of the secondary transmitter at the separation distance used in the testing.

For simultaneous transmission analysis, Bluetooth SAR is below:

Bluetooth:

	Average Power (dBm)	Output Power (mW)	$P_{\text{th},m}$ (mW)	$SAR_{\lim}$ (W/kg)	$SAR_1$ (W/kg)	$P_{\text{available}}$ (mW)
Head	3.08	2.032	20	2.0	0.616	13.84
Body	3.08	2.032	20	2.0	1.020	9.80

The Bluetooth output power of the secondary transmitter is less than  $P_{\text{available}}$ , So SAR measurement for the secondary transmitter is not necessary.

**Maximum SAR value and the sum of the 10-g SAR for WWAN & WLAN – Head**

WWAN Band	WWAN Max SAR (W/kg)	2.4GWLAN Max SAR (W/kg)	5.2GWLAN Max SAR (W/kg)	5.8GWLAN Max SAR (W/kg)	Max SAR Sum (W/kg)	Limit (W/kg)
GSM900	0.093	0.172	0.219	0.248	0.341	2.0
DCS1800	0.009	0.172	0.219	0.248	0.257	
WCDMA900	0.616	0.172	0.219	0.248	<b>0.864</b>	
WCDMA2100	0.228	0.172	0.219	0.248	0.476	
LTE Band 1	0.096	0.172	0.219	0.248	0.344	
LTE Band 3	0.083	0.172	0.219	0.248	0.331	
LTE Band 7	0.072	0.172	0.219	0.248	0.320	
LTE Band 8	0.593	0.172	0.219	0.248	0.841	
LTE Band 20	0.104	0.172	0.219	0.248	0.352	
LTE Band 38	0.047	0.172	0.219	0.248	0.295	
LTE Band 40	0.051	0.172	0.219	0.248	0.299	

**Maximum SAR value and the sum of the 10-g SAR for WWAN & WLAN - Body**

WWAN Band	WWAN Max SAR (W/kg)	2.4GWLAN Max SAR (W/kg)	5.2GWLAN Max SAR (W/kg)	5.8GWLAN Max SAR (W/kg)	Max SAR Sum (W/kg)	Limit (W/kg)
GSM900	0.057	0.292	0.268	0.361	0.418	2.0
DCS1800	0.006	0.292	0.268	0.361	0.367	
WCDMA900	0.337	0.292	0.268	0.361	0.698	
WCDMA2100	0.507	0.292	0.268	0.361	0.868	
LTE Band 1	0.427	0.292	0.268	0.361	0.788	
LTE Band 3(L)	0.975	0.292	0.268	0.361	1.336	
LTE Band 3	1.020	0.292	0.268	0.361	<b>1.381</b>	
LTE Band 3(H)	0.968	0.292	0.268	0.361	1.329	
LTE Band 7(L)	0.942	0.292	0.268	0.361	1.303	
LTE Band 7	1.006	0.292	0.268	0.361	1.367	
LTE Band 7(H)	0.921	0.292	0.268	0.361	1.282	
LTE Band 8	0.109	0.292	0.268	0.361	0.470	
LTE Band 20	0.078	0.292	0.268	0.361	0.439	
LTE Band 38	0.357	0.292	0.268	0.361	0.718	
LTE Band 40	0.693	0.292	0.268	0.361	1.054	

**Remark:**

- 1 WLAN and Bluetooth share the same antenna, and cannot transmit simultaneously.
- 2 GSM ,WCDMA and LTE share the same antenna, and cannot transmit simultaneously.
- 3 The maximum SAR summation is calculated based on the same configuration and test position.  
If 10g-SAR summation < 2.0W/kg , simultaneous SAR measurement is not necessary.
- 4 When the maximum SAR summation  $\geq 1.0$ W/kg on Body, WWAN, WLAN2.4G, WLAN5.2G, WLAN5.8G for low and high Channels are necessary to be tested and the test results please refer to the SAR Measurement Results.

### 4.3. SAR Measurement Results

#### SAR Values for GSM900 Band- Head

Frequency		Mode/Band	Side	Test Position	SAR(10g) (W/kg)	Power Drift(%)	Ref.Plot #
MHz	Channel						
902.6	63	GSM900	Left	Touch	<b>0.093</b>	0.29	1
902.6	63	GSM900	Left	Tilt	0.052	3.21	--
902.6	63	GSM900	Right	Touch	0.075	1.05	--
902.6	63	GSM900	Right	Tilt	0.036	1.28	--

**Note:**

1.When the 10-g SAR is  $\leq 1.0W/kg$ , testing for low and high channel is optional.

#### SAR Values for GSM900 Band-Body

Frequency		Service/Headset	Test Position	Spacing(mm)	SAR(10g) (W/kg)	Power Drift(%)	Ref.Plot #
MHz	Channel						
902.6	63	GPRS 2TS	Front	5	0.030	3.62	--
902.6	63	GPRS 2TS	Rear	5	<b>0.057</b>	-4.50	2

**Note:**

1.When the 10-g SAR is  $\leq 1.0W/kg$ , testing for low and high channel is optional.

2.The EUT is a Class B Mobile Phone which can be attached to both GPRS and GSM services,using one service at a time

3.The Multi-slot Classes of EUT is Class12 which has maximum 1 Downlink slots and 4 Uplink slots, the maximum active slots is 5, when perform the multiple slots scan, 1DL+2UL is the worse case.

#### SAR Values for DCS1800Band-Head

Frequency		Mode/Band	Side	Test Position	SAR(10g) (W/kg)	Power Drift(%)	Ref.Plot #
MHz	Channel						
1747.4	698	DCS1800	Left	Touch	<b>0.009</b>	2.70	3
1747.4	698	DCS1800	Left	Tilt	0.005	3.21	--
1747.4	698	DCS1800	Right	Touch	0.007	0.87	--
1747.4	698	DCS1800	Right	Tilt	0.003	2.18	--

**Note:**

1.When the 10-g SAR is  $\leq 1.0W/kg$ , testing for low and high channel is optional.

#### SAR Values for DCS1800 Band-Body

Frequency		Service/Headset	Test Position	Spacing(mm)	SAR(10g) (W/kg)	Power Drift(%)	Ref.Plot #
MHz	Channel						
1747.4	698	GPRS 2TS	Front	5	0.003	-1.10	4
1747.4	698	GPRS 2TS	Rear	5	<b>0.006</b>	-0.31	--

**Note:**

1.When the 10-g SAR is  $\leq 1.0W/kg$ , testing for low and high channel is optional.

2.The EUT is a Class B Mobile Phone which can be attached to both GPRS and GSM services,using one service at a time

3.The Multi-slot Classes of EUT is Class12 which has maximum 1 Downlink slots and 4 Uplink slots, the maximum active slots is 5, when perform the multiple slots scan, 1DL+2UL is the worse case.

#### SAR Values for WCDMA Band VIII-Head

Frequency		Service/Headset	Side	Test Position	SAR(10g) (W/kg)	Power Drift(%)	Ref.Plot #
MHz	Channel						
897.6	2788	RMC	Left	Touch	<b>0.616</b>	3.51	5
897.6	2788	RMC	Left	Tilt	0.365	1.57	--
897.6	2788	RMC	Right	Touch	0.547	-0.25	--
897.6	2788	RMC	Right	Tilt	0.285	3.25	--

**Note:**

1.When the 10-g SAR is  $\leq 1.0W/kg$ , testing for low and high channel is optional.

2.The default test configuration is to measure SAR with an established radio link between the EUT and a communication test set using a 12.2kbps RMC(reference measurement channel) configuration in test loop mode.

#### SAR Values for WCDMA Band VIII -Body

Frequency		Mode/Band	Test Position	Spacing(mm)	SAR(10g) (W/kg)	Power Drift(%)	Ref.Plot #
MHz	Channel						
897.6	2788	RMC	Front	5	0.178	0.30	--
897.6	2788	RMC	Rear	5	<b>0.337</b>	1.55	6

**Note:**

1.When the 10-g SAR is  $\leq 1.0W/kg$ , testing for low and high channel is optional.

2.The default test configuration is to measure SAR with an established radio link between the EUT and a communication test set using a 12.2kbps RMC(reference measurement channel) configuration in test loop mode

**SAR Values for WCDMA Band I-Head**

Frequency		Service/Headset	Side	Test Position	SAR(10g) (W/kg)	Power Drift(%)	Ref.Plot #
MHz	Channel						
1950.0	9750	RMC	Left	Touch	<b>0.228</b>	0.07	7
1950.0	9750	RMC	Left	Tilt	0.165	3.25	--
1950.0	9750	RMC	Right	Touch	0.196	1.06	--
1950.0	9750	RMC	Right	Tilt	0.123	0.18	--

**Note:**

1. When the 10-g SAR is  $\leq 1.0\text{W/kg}$ , testing for low and high channel is optional.
2. The default test configuration is to measure SAR with an established radio link between the EUT and a communication test set using a 12.2kbps RMC(reference measurement channel) configuration in test loop mode.

**SAR Values for WCDMA Band I-Body**

Frequency		Mode/Band	Test Position	Spacing(mm)	SAR(10g) (W/kg)	Power Drift(%)	Ref.Plot #
MHz	Channel						
1950.0	9750	RMC	Front	5	<b>0.507</b>	-3.57	8
1922.4	9612	RMC	Front	5	0.305	3.69	--
1977.6	9888	RMC	Front	5	0.470	2.58	--
1950.0	9750	RMC	Rear	5	0.287	0.17	--

**Note:**

1. When the 10-g SAR is  $\leq 1.0\text{W/kg}$ , testing for low and high channel is optional.
2. The default test configuration is to measure SAR with an established radio link between the EUT and a communication test set using a 12.2kbps RMC(reference measurement channel) configuration in test loop mode.

**SAR Values for WLAN2450 Band -Head**

Frequency		Service/Headset	Side	Test Position	SAR(10g) (W/kg)	Power Drift(%)	Ref.Plot #
MHz	Channel						
2442.0	7	802.11b	Left	Touch	<b>0.172</b>	0.25	9
2442.0	7	802.11b	Left	Tilt	0.102	3.62	--
2442.0	7	802.11b	Right	Touch	0.152	1.08	--
2442.0	7	802.11b	Right	Tilt	0.063	2.17	--

**Note:**

1. When the 10-g SAR is  $\leq 1.0\text{W/kg}$ , testing for low and high channel is optional.
2. The default test configuration is to measure SAR with an established radio link between the EUT and a communication test set using a 12.2kbps RMC(reference measurement channel) configuration in test loop mode.

**SAR Values for WLAN2450 Band -Body**

Frequency		Mode/Band	Test Position	Spacing(mm)	SAR(10g) (W/kg)	Power Drift(%)	Ref.Plot #
MHz	Channel						
2442.0	7	802.11b	Front	5	0.192	3.69	--
2442.0	7	802.11b	Rear	5	<b>0.292</b>	0.35	10

**Note:**

1. When the 10-g SAR is  $\leq 1.0\text{W/kg}$ , testing for low and high channel is optional.
2. The result was tested under the lowest data rate 1Mbps for 802.11b.

**SAR Values for WLAN5200 Band -Head**

Frequency		Mode/Band	Side	Test Position	SAR(10g) (W/kg)	Power Drift(%)	Ref.Plot #
MHz	Channel						
5210.0	42	802.11a	Left	Touch	<b>0.219</b>	3.78	11
5210.0	42	802.11a	Left	Tilt	0.129	3.21	--
5210.0	42	802.11a	Right	Touch	0.185	1.58	--
5210.0	42	802.11a	Right	Tilt	0.091	3.25	--

**Note:**

1. When the 10-g SAR is  $\leq 1.0\text{W/kg}$ , testing for low and high channel is optional.
2. The result was tested under the lowest data rate 6Mbps for 802.11a.

**SAR Values for WLAN5200 Band -Body**

Frequency		Mode/Band	Test Position	Spacing(mm)	SAR(10g) (W/kg)	Power Drift(%)	Ref.Plot #
MHz	Channel						
5210.0	42	802.11a	Front	0	0.145	3.63	--
5210.0	42	802.11a	Rear	0	<b>0.268</b>	0.29	12

**Note:**

1. When the 10-g SAR is  $\leq 1.0\text{W/kg}$ , testing for low and high channel is optional.

2. The result was tested under the lowest data rate 6Mbps for 802.11a.

#### SAR Values for 5.8G SRD Band -Head

Frequency		Mode/Band	Side	Test Position	SAR(10g) (W/kg)	Power Drift(%)	Ref.Plot #
MHz	Channel						
5755.0	151	802.11a	Left	Touch	<b>0.248</b>	1.43	13
5755.0	151	802.11a	Left	Tilt	0.155	3.21	--
5755.0	151	802.11a	Right	Touch	0.212	0.58	--
5755.0	151	802.11a	Right	Tilt	0.120	3.64	--

#### Note:

1. When the 10-g SAR is  $\leq 1.0W/kg$ , testing for low and high channel is optional.
2. The result was tested under the lowest data rate 6Mbps for 802.11a.

#### SAR Values for 5.8G SRD Band -Body

Frequency		Mode/Band	Test Position	Spacing(mm)	SAR(10g) (W/kg)	Power Drift(%)	Ref.Plot #
MHz	Channel						
5755.0	151	802.11a	Front	0	0.201	3.69	--
5755.0	151	802.11a	Rear	0	<b>0.361</b>	0.95	14

#### Note:

1. When the 10-g SAR is  $\leq 1.0W/kg$ , testing for low and high channel is optional.
2. The result was tested under the lowest data rate 6Mbps for 802.11a.

#### SAR Values for E-UTRA Band 1-Head

Frequency		Service/Headset	Side	Test Position	SAR(10g) (W/kg)	Power Drift(%)	Ref.Plot #
MHz	Channel						
1950.0	18300	RMC	Left	Touch	<b>0.096</b>	-0.44	15
1950.0	18300	RMC	Left	Tilt	0.052	3.21	--
1950.0	18300	RMC	Right	Touch	0.075	1.02	--
1950.0	18300	RMC	Right	Tilt	0.031	-1.50	--

#### Note:

1. When the 10-g SAR is  $\leq 1.0W/kg$ , testing for low and high channel is optional.
2. The default test configuration is to measure SAR with an established radio link between the EUT and a communication test set using a 12.2kbps RMC(reference measurement channel) configuration in test loop mode.

#### SAR Values for E-UTRA Band 1-Body

Frequency		Mode/Band	Test Position	Spacing(mm)	SAR(10g) (W/kg)	Power Drift(%)	Ref.Plot #
MHz	Channel						
1950.0	18300	RMC	Front	5	0.225	3.64	--
1950.0	18300	RMC	Rear	5	<b>0.427</b>	-1.07	16

#### Note:

1. When the 10-g SAR is  $\leq 1.0W/kg$ , testing for low and high channel is optional.
2. The default test configuration is to measure SAR with an established radio link between the EUT and a communication test set using a 12.2kbps RMC(reference measurement channel) configuration in test loop mode.

#### SAR Values for E-UTRA Band 3 -Head

Frequency		Service/Headset	Side	Test Position	SAR(10g) (W/kg)	Power Drift(%)	Ref.Plot #
MHz	Channel						
1747.5	19575	RMC	Left	Touch	<b>0.083</b>	3.26	17
1747.5	19575	RMC	Left	Tilt	0.041	3.18	--
1747.5	19575	RMC	Right	Touch	0.070	2.03	--
1747.5	19575	RMC	Right	Tilt	0.035	0.80	--

#### Note:

1. When the 10-g SAR is  $\leq 1.0W/kg$ , testing for low and high channel is optional.
2. The default test configuration is to measure SAR with an established radio link between the EUT and a communication test set using a 12.2kbps RMC(reference measurement channel) configuration in test loop mode.

#### SAR Values for E-UTRA Band 3 -Body

Frequency		Mode/Band	Test Position	Spacing(mm)	SAR(10g) (W/kg)	Power Drift(%)	Ref.Plot #
MHz	Channel						
1747.5	19575	RMC	Front	5	0.840	3.60	--
1747.5	19575	RMC	Rear	5	<b>1.020</b>	1.16	18
1720.0	19300	RMC	Rear	5	0.975	0.17	--
1775.0	19850	RMC	Rear	5	0.968	2.05	--

#### Note:

1. When the 10-g SAR is  $\leq 1.0\text{W/kg}$ , testing for low and high channel is optional.
2. The default test configuration is to measure SAR with an established radio link between the EUT and a communication test set using a 12.2kbps RMC(reference measurement channel) configuration in test loop mode.

**SAR Values for E-UTRA Band 7 -Head**

Frequency		Service/Headset	Side	Test Position	SAR(10g) (W/kg)	Power Drift(%)	Ref.Plot #
MHz	Channel						
2535.0	21100	RMC	Left	Touch	<b>0.072</b>	-1.38	19
2535.0	21100	RMC	Left	Tilt	0.045	3.21	--
2535.0	21100	RMC	Right	Touch	0.060	1.08	--
2535.0	21100	RMC	Right	Tilt	0.031	2.05	--

**Note:**

1. When the 10-g SAR is  $\leq 1.0\text{W/kg}$ , testing for low and high channel is optional.
2. The default test configuration is to measure SAR with an established radio link between the EUT and a communication test set using a 12.2kbps RMC(reference measurement channel) configuration in test loop mode.

**SAR Values for E-UTRA Band 7 -Body**

Frequency		Mode/Band	Test Position	Spacing(mm)	SAR(10g) (W/kg)	Power Drift(%)	Ref.Plot #
MHz	Channel						
2535.0	21100	RMC	Front	5	0.687	1.60	--
2535.0	21100	RMC	Rear	5	<b>1.006</b>	4.48	20
2510.0	20850	RMC	Rear	5	0.942	1.00	--
2560.0	21350	RMC	Rear	5	0.921	3.02	--

**Note:**

1. When the 10-g SAR is  $\leq 1.0\text{W/kg}$ , testing for low and high channel is optional.
2. The default test configuration is to measure SAR with an established radio link between the EUT and a communication test set using a 12.2kbps RMC(reference measurement channel) configuration in test loop mode.

**SAR Values for E-UTRA Band 8 -Head**

Frequency		Service/Headset	Side	Test Position	SAR(10g) (W/kg)	Power Drift(%)	Ref.Plot #
MHz	Channel						
897.5	21625	RMC	Left	Touch	<b>0.593</b>	-1.39	21
897.5	21625	RMC	Left	Tilt	0.302	0.80	--
897.5	21625	RMC	Right	Touch	0.524	2.15	--
897.5	21625	RMC	Right	Tilt	0.274	3.01	--

**Note:**

1. When the 10-g SAR is  $\leq 1.0\text{W/kg}$ , testing for low and high channel is optional.
2. The default test configuration is to measure SAR with an established radio link between the EUT and a communication test set using a 12.2kbps RMC(reference measurement channel) configuration in test loop mode.

**SAR Values for E-UTRA Band 8 -Body**

Frequency		Mode/Band	Test Position	Spacing(mm)	SAR(10g) (W/kg)	Power Drift(%)	Ref.Plot #
MHz	Channel						
897.5	21625	RMC	Front	5	0.085	3.96	--
897.5	21625	RMC	Rear	5	<b>0.109</b>	0.56	22

**Note:**

1. When the 10-g SAR is  $\leq 1.0\text{W/kg}$ , testing for low and high channel is optional.
2. The default test configuration is to measure SAR with an established radio link between the EUT and a communication test set using a 12.2kbps RMC(reference measurement channel) configuration in test loop mode.

**SAR Values for E-UTRA Band 20 -Head**

Frequency		Service/Headset	Side	Test Position	SAR(10g) (W/kg)	Power Drift(%)	Ref.Plot #
MHz	Channel						
847.0	24300	RMC	Left	Touch	<b>0.104</b>	-0.16	23
847.0	24300	RMC	Left	Tilt	0.056	3.21	--
847.0	24300	RMC	Right	Touch	0.085	0.50	--
847.0	24300	RMC	Right	Tilt	0.042	1.07	--

**Note:**

1. When the 10-g SAR is  $\leq 1.0\text{W/kg}$ , testing for low and high channel is optional.
2. The default test configuration is to measure SAR with an established radio link between the EUT and a communication test set using a 12.2kbps RMC(reference measurement channel) configuration in test loop mode.

**SAR Values for E-UTRA Band 20 -Body**

Frequency		Mode/Band	Test Position	Spacing(mm)	SAR(10g) (W/kg)	Power Drift(%)	Ref.Plot #
MHz	Channel						

847.0	24300	RMC	Front	5	0.041	3.08	--
847.0	24300	RMC	Rear	5	<b>0.078</b>	0.04	24

**Note:**

1. When the 10-g SAR is  $\leq 1.0\text{W/kg}$ , testing for low and high channel is optional.
2. The default test configuration is to measure SAR with an established radio link between the EUT and a communication test set using a 12.2kbps RMC(reference measurement channel) configuration in test loop mode.

**SAR Values for E-UTRA Band 38 -Head**

Frequency		Service/Headset	Side	Test Position	SAR(10g) (W/kg)	Power Drift(%)	Ref.Plot #
MHz	Channel						
2595	38000	RMC	Left	Touch	<b>0.047</b>	-0.55	25
2595	38000	RMC	Left	Tilt	0.023	3.10	--
2595	38000	RMC	Right	Touch	0.035	2.50	--
2595	38000	RMC	Right	Tilt	0.020	1.01	--

**Note:**

1. When the 10-g SAR is  $\leq 1.0\text{W/kg}$ , testing for low and high channel is optional.
2. The default test configuration is to measure SAR with an established radio link between the EUT and a communication test set using a 12.2kbps RMC(reference measurement channel) configuration in test loop mode.

**SAR Values for E-UTRA Band 38 -Body**

Frequency		Mode/Band	Test Position	Spacing(mm)	SAR(10g) (W/kg)	Power Drift(%)	Ref.Plot #
MHz	Channel						
2595	38000	RMC	Front	5	0.207	1.32	--
2595	38000	RMC	Rear	5	<b>0.357</b>	1.90	26

**Note:**

1. When the 10-g SAR is  $\leq 1.0\text{W/kg}$ , testing for low and high channel is optional.
2. The default test configuration is to measure SAR with an established radio link between the EUT and a communication test set using a 12.2kbps RMC(reference measurement channel) configuration in test loop mode.

**SAR Values for E-UTRA Band 40 -Head**

Frequency		Service/Headset	Side	Test Position	SAR(10g) (W/kg)	Power Drift(%)	Ref.Plot #
MHz	Channel						
2350	39150	RMC	Left	Touch	<b>0.051</b>	-0.82	27
2350	39150	RMC	Left	Tilt	0.031	0.02	--
2350	39150	RMC	Right	Touch	0.043	2.15	--
2350	39150	RMC	Right	Tilt	0.027	1.11	--

**Note:**

1. When the 10-g SAR is  $\leq 1.0\text{W/kg}$ , testing for low and high channel is optional.
2. The default test configuration is to measure SAR with an established radio link between the EUT and a communication test set using a 12.2kbps RMC(reference measurement channel) configuration in test loop mode.

**SAR Values for E-UTRA Band 40 -Body**

Frequency		Mode/Band	Test Position	Spacing(mm)	SAR(10g) (W/kg)	Power Drift(%)	Ref.Plot #
MHz	Channel						
2350	39150	RMC	Front	5	0.306	2.03	--
2350	39150	RMC	Rear	5	<b>0.693</b>	1.56	28

**Note:**

1. When the 10-g SAR is  $\leq 1.0\text{W/kg}$ , testing for low and high channel is optional.
2. The default test configuration is to measure SAR with an established radio link between the EUT and a communication test set using a 12.2kbps RMC(reference measurement channel) configuration in test loop mode.



#### 4.4. Measurement Uncertainty (450MHz-6GHz)

The following measurement uncertainty levels have been estimated for tests performed on the EUT as specified in IEEE 1528: 2013. This uncertainty represents an expanded uncertainty expressed at approximately the 95% confidence level using a coverage factor of k=2.

Uncertainty Component	Tol (+-%)	Prob. Dist.	Div.	Ci (1g)	Ci (10g)	1g Ui (+-%)	10g Ui (+-%)	Veff
<b>Measurement System</b>								
Probe calibration	5.8	N	1	1	1	5.80	5.80	∞
Axial Isotropy	3.5	R	√3	$\sqrt{1-C_p}$	$\sqrt{1-C_p}$	1.43	1.43	∞
Hemispherical Isotropy	5.9	R	√3	$\sqrt{C_p}$	$\sqrt{C_p}$	2.41	2.41	∞
Boundary effect	1.0	R	√3	1	1	0.58	0.58	∞
Linearity	4.7	R	√3	1	1	2.71	2.71	∞
System detection limits	1.0	R	√3	1	1	0.58	0.58	∞
Readout Electronics	0.5	N	1	1	1	0.50	0.50	∞
Response Time	0.0	R	√3	1	1	0.00	0.00	∞
Integration Time	1.4	R	√3	1	1	0.81	0.81	∞
RF ambient Conditions - Noise	3.0	R	√3	1	1	1.73	1.73	∞
RF ambient Conditions - Reflections	3.0	R	√3	1	1	1.73	1.73	∞
Probe positioner Mechanical Tolerance	1.4	R	√3	1	1	0.81	0.81	∞
Probe positioning with respect to Phantom Shell	1.4	R	√3	1	1	0.81	0.81	∞
Max. SAR Evaluation	1.0	R	√3	1	1	0.6	0.6	∞
<b>Test sample Related</b>								
Device positioning	2.6	N	1	1	1	2.6	2.6	11
Device holder	3.0	N	1	1	1	3.0	3.0	7
Drift of output power	5.0	N	√3	1	1	2.89	2.89	∞
<b>Phantom and Tissue Parameters</b>								
Phantom uncertainty	4.00	R	√3	1	1	2.31	2.31	∞
Liquid conductivity (target)	2.50	N	1	0.78	0.71	1.95	1.78	5
Liquid conductivity (meas)	4.00	N	1	0.23	0.26	0.92	1.04	5
Liquid Permittivity (target)	2.50	N	1	0.78	0.71	1.95	1.78	∞
Liquid Permittivity (meas)	5.00	N	1	0.23	0.26	1.15	1.30	∞
Combined Standard		RSS		$U_c = \sqrt{\sum_{i=1}^n C_i^2 U_i^2}$		10.63 %	10.54%	
Expanded Uncertainty (95% Confidence interval)				U = k U <sub>c</sub> , k=2		21.26 %	21.08%	

### 4.5. System Check Results

Test mode:900MHz  
 Product Description:Validation  
 Model:Dipole SID900  
 E-Field Probe: SSE2(SN 31/17 EPGO324)  
 Test Date: April 26, 2021

Medium(liquid type)	HSL_900
Frequency (MHz)	900.0000
Relative permittivity (real part)	42.58
Conductivity (S/m)	0.94
Input power	100mW
Crest Factor	1.0
Conversion Factor	1.54
Variation (%)	-1.400000
SAR 10g (W/Kg)	0.701230
SAR 1g (W/Kg)	1.122250

#### SURFACE SAR

#### VOLUME SAR

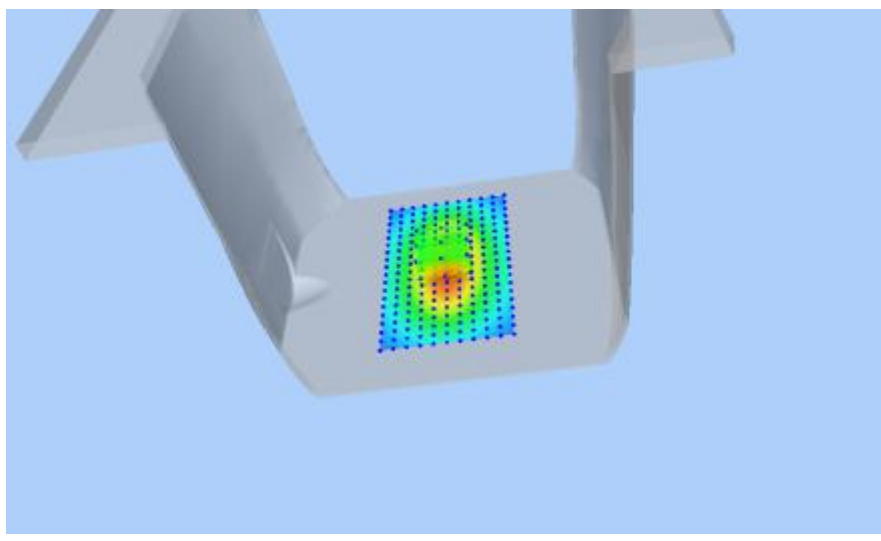
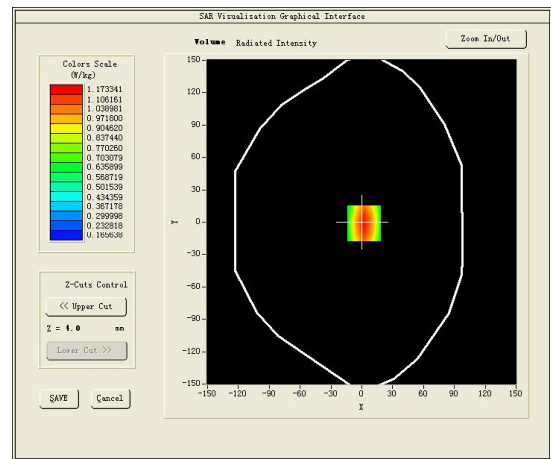
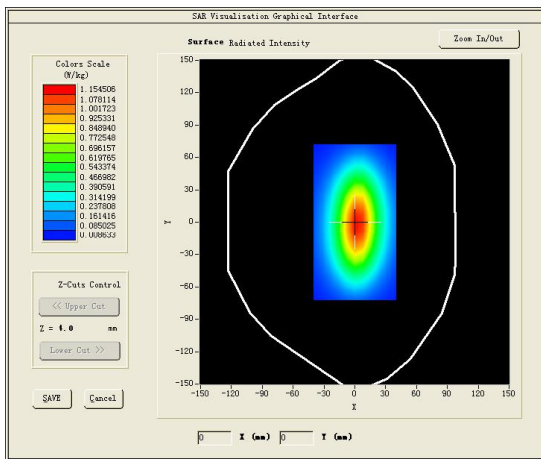

Test mode:1800MHz  
 Product Description:Validation  
 Model:Dipole SID1800  
 E-Field Probe: SSE2(SN 31/17 EPGO324)  
 Test Date: April 30, 2021

Medium(liquid type)	HSL_1800
Frequency (MHz)	1800.0000
Relative permittivity (real part)	40.64
Conductivity (S/m)	1.43
Input power	100mW
Crest Factor	1.0
Conversion Factor	1.65
Variation (%)	-3.120000
SAR 10g (W/Kg)	1.863690
SAR 1g (W/Kg)	4.001231

**SURFACE SAR**

**VOLUME SAR**

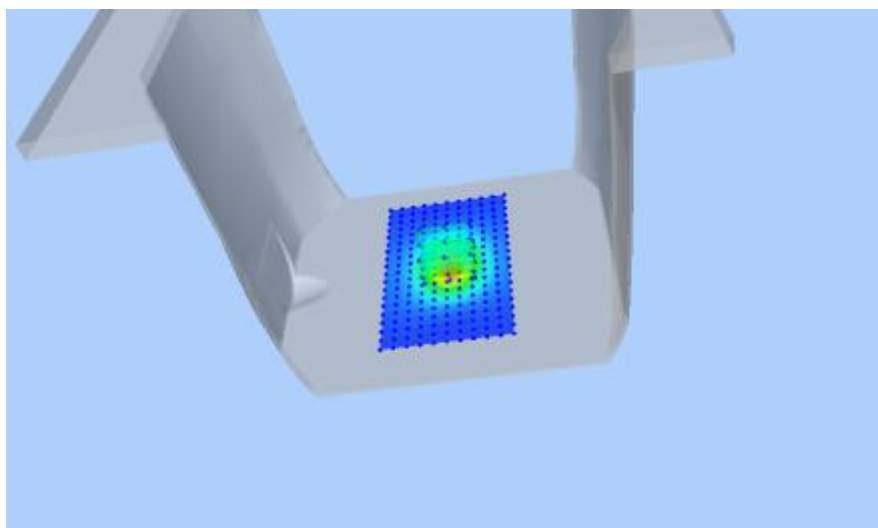
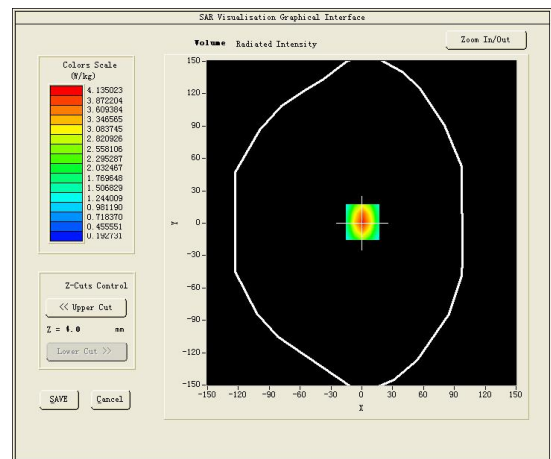
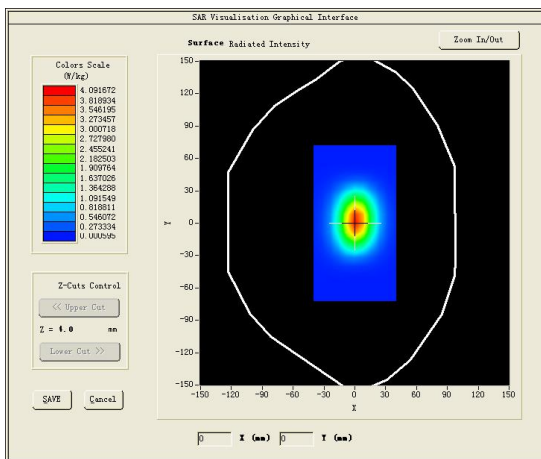

Test mode:2000MHz  
 Product Description:Validation  
 Model:Dipole SID2000  
 E-Field Probe: SSE2(SN 31/17 EPGO324)  
 Test Date: May 12, 2021

Medium(liquid type)	HSL_2000
Frequency (MHz)	2000.0000
Relative permittivity (real part)	39.17
Conductivity (S/m)	1.42
Input power	100mW
Crest Factor	1.0
Conversion Factor	1.83
Variation (%)	-3.420000
SAR 10g (W/Kg)	1.933212
SAR 1g (W/Kg)	4.012030

**SURFACE SAR**

**VOLUME SAR**

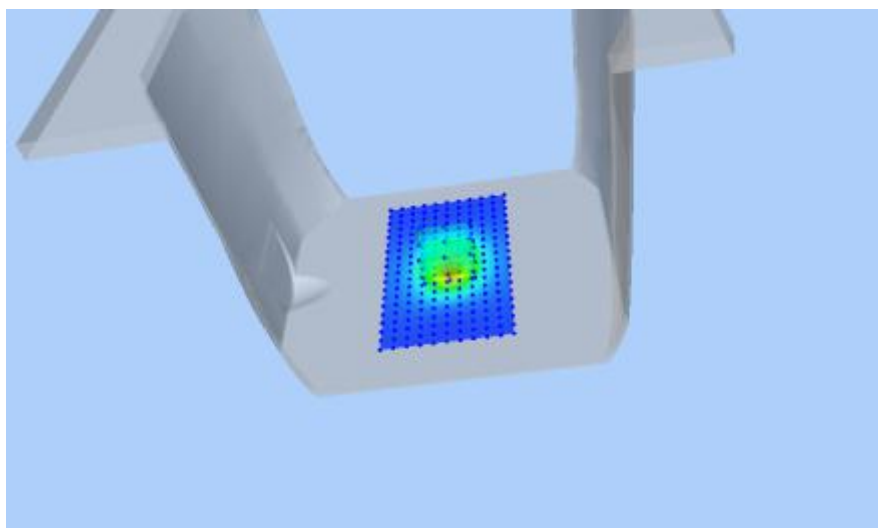
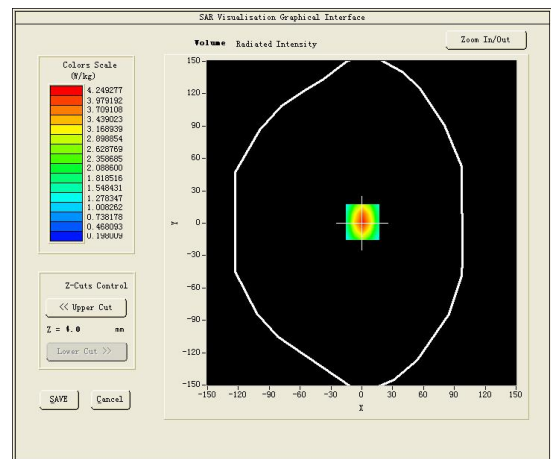
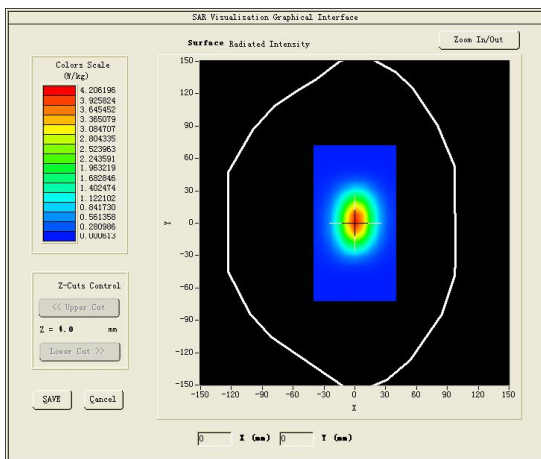

Test mode:2450MHz  
 Product Description:Validation  
 Model:Dipole SID2450  
 E-Field Probe: SSE2(SN 31/17 EPGO324)  
 Test Date: May 24, 2021

Medium(liquid type)	HSL_2450
Frequency (MHz)	2450.0000
Relative permittivity (real part)	38.35
Conductivity (S/m)	1.78
Input power	100mW
Crest Factor	1.0
Conversion Factor	1.91
Variation (%)	-1.520000
SAR 10g (W/Kg)	2.339721
SAR 1g (W/Kg)	4.923420

**SURFACE SAR**

**VOLUME SAR**

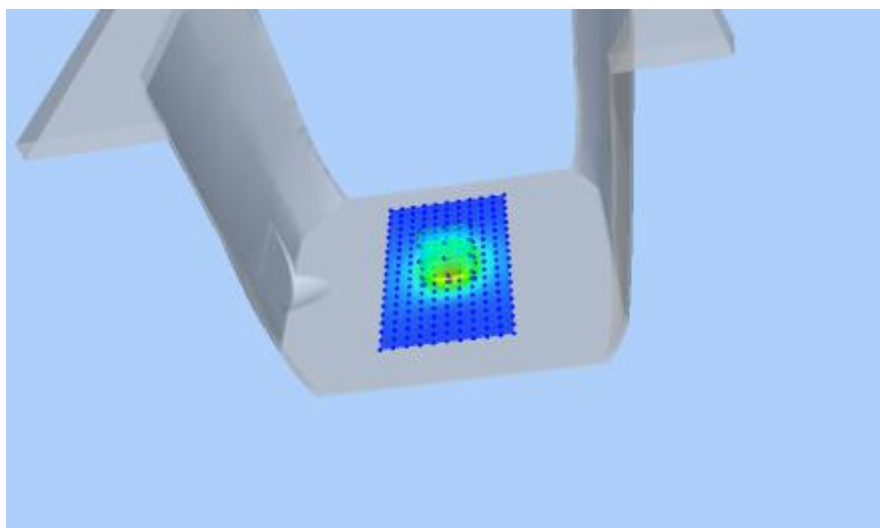
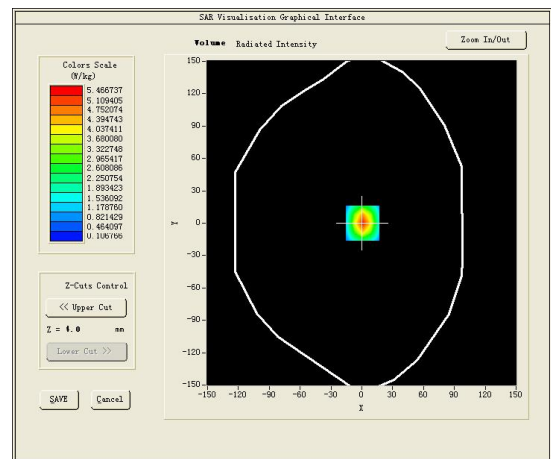
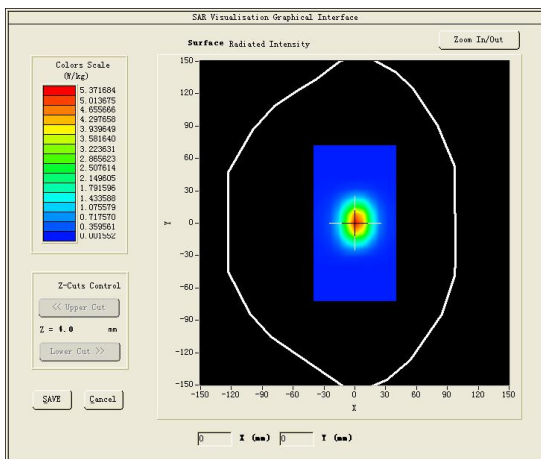

Test mode:2600MHz  
 Product Description:Validation  
 Model:Dipole SID2600  
 E-Field Probe: SSE2(SN 31/17 EPGO324)  
 Test Date: May 30, 2021

Medium(liquid type)	HSL_2600
Frequency (MHz)	2600.0000
Relative permittivity (real part)	40.35
Conductivity (S/m)	1.90
Input power	100mW
Crest Factor	1.0
Conversion Factor	1.89
Variation (%)	-1.200000
SAR 10g (W/Kg)	2.453607
SAR 1g (W/Kg)	5.600611
<b>SURFACE SAR</b>	<b>VOLUME SAR</b>

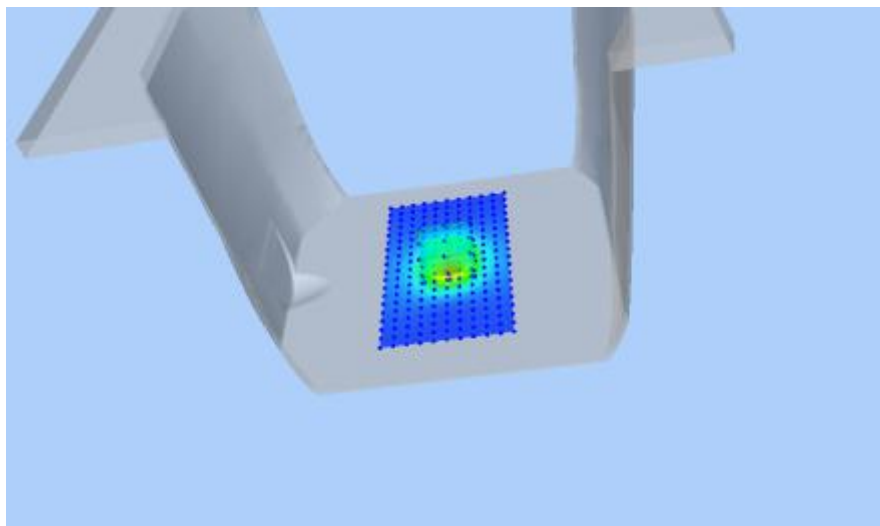
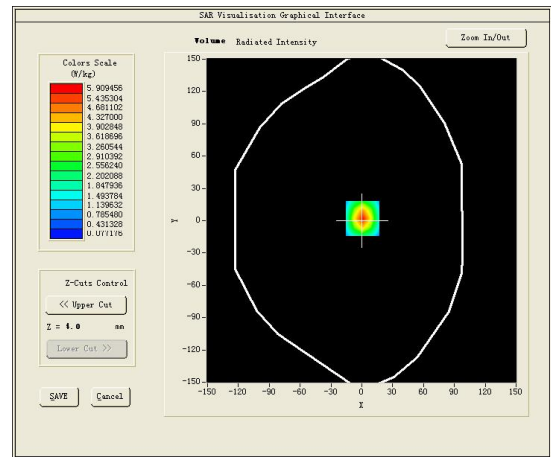
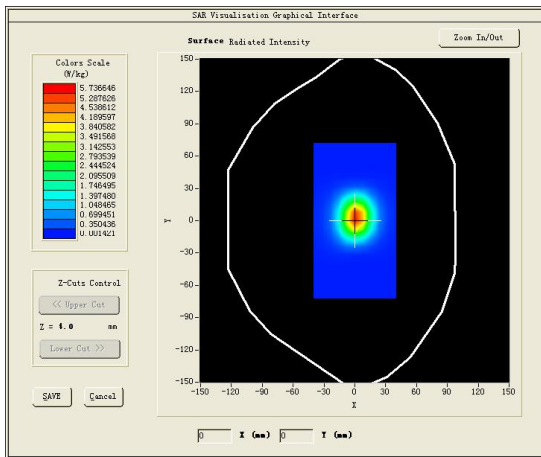

Test mode:5000MHz  
 Product Description:Validation  
 Model:Dipole SID5000  
 E-Field Probe: SSE2(SN 31/17 EPGO324)  
 Test Date: June 15, 2021

Medium(liquid type)	HSL_5000
Frequency (MHz)	5000.0000
Relative permittivity (real part)	35.81
Conductivity (S/m)	4.59
Input power	100mW
Crest Factor	1.0
Conversion Factor	1.50
Variation (%)	2.410000
SAR 10g (W/Kg)	2.112010
SAR 1g (W/Kg)	7.542101
<b>SURFACE SAR</b>	<b>VOLUME SAR</b>

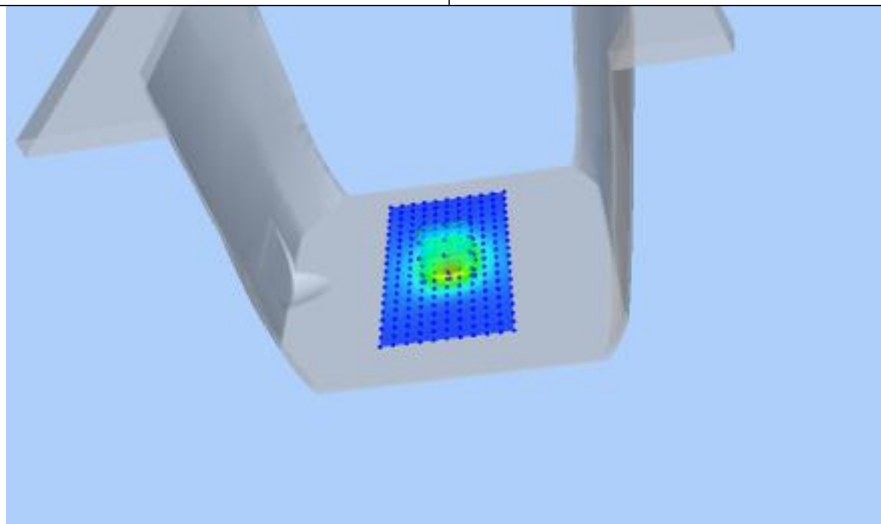
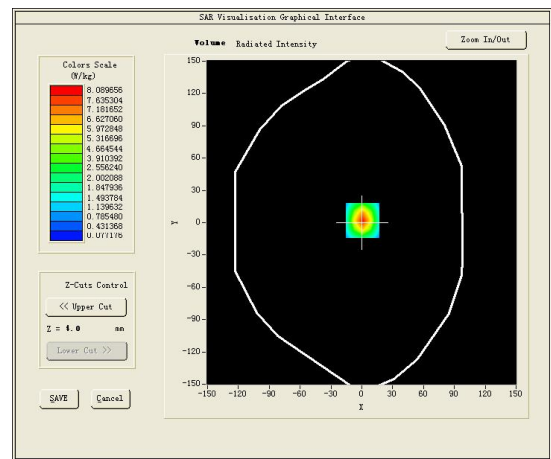
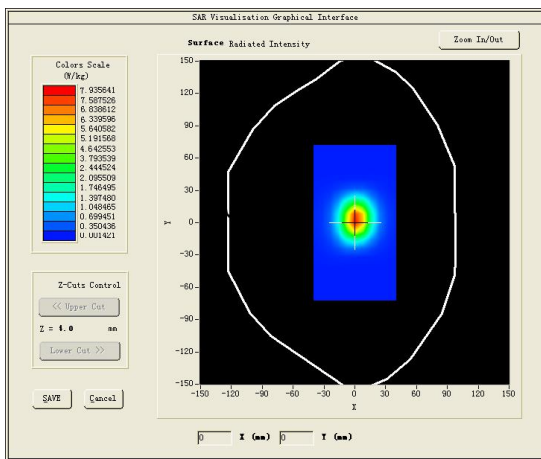

**4.6. SAR Test Graph Results**

#1 Test Mode:GSM900MHz,Middle channel(Left head cheek)  
 Product Description:mobile phone  
 Model:Librem 5  
 Test Date: April 26, 2021

Medium(liquid type)	HSL_900
Frequency (MHz)	897.4000
Relative permittivity (real part)	42.59
Conductivity (S/m)	0.96
E-Field Probe	SN 31/17 EPGO324
Crest Factor	8.0
Conversion Factor	1.54
Sensor	4mm
Area Scan	dx=8mm dy=8mm
Zoom Scan	5x5x7,dx=8mm dy=8mm dz=5mm
Variation (%)	0.290000
SAR 10g (W/Kg)	0.096697
SAR 1g (W/Kg)	0.192614
<b>SURFACE SAR</b>	<b>VOLUME SAR</b>

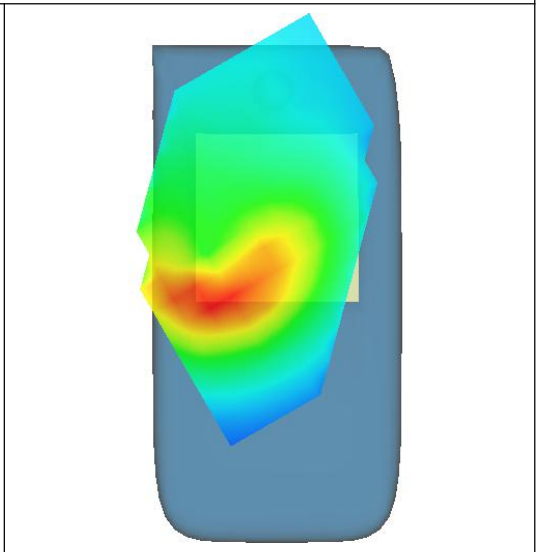
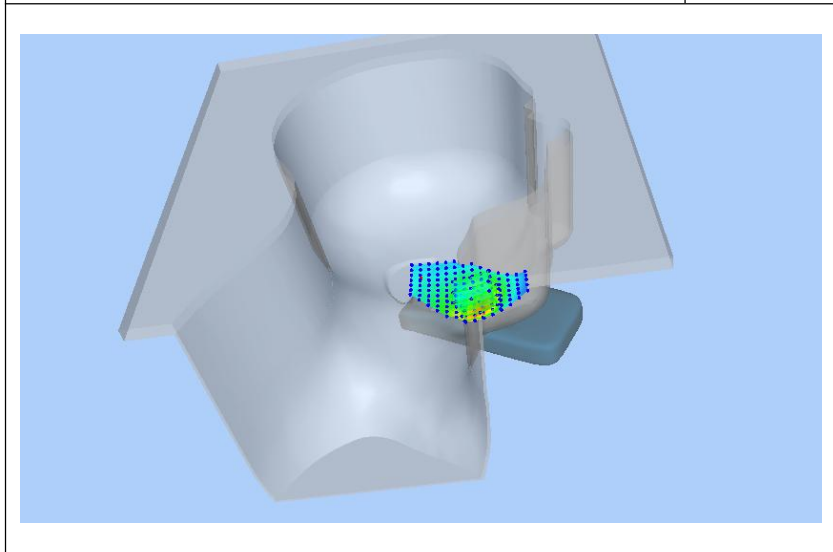
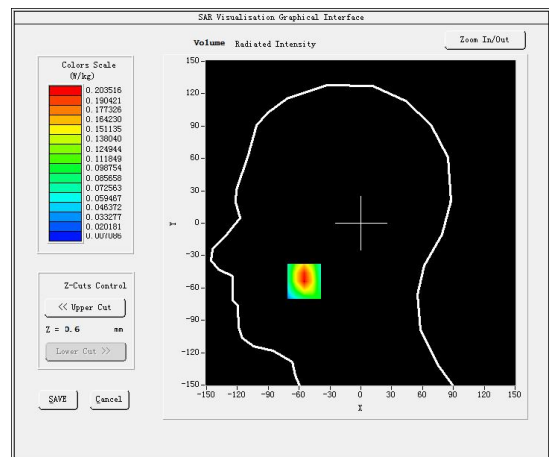
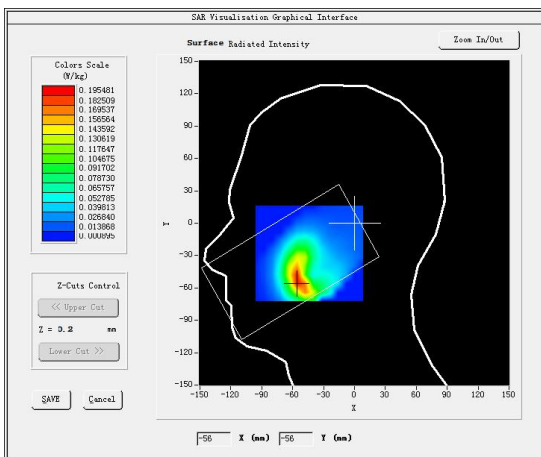



#2

Test Mode:GPRS900MHz,Middle channel(Body-LCD Down)

Product Description:mobile phone

Model:Librem 5

Test Date: April 26, 2021

Medium(liquid type)	HSL_900
Frequency (MHz)	897.4000
Relative permittivity (real part)	42.58
Conductivity (S/m)	0.95
E-Field Probe	SN 31/17 EPGO324
Crest Factor	4.0
Conversion Factor	1.54
Sensor	4mm
Area Scan	dx=8mm dy=8mm
Zoom Scan	5x5x7,dx=8mm dy=8mm dz=5mm
Variation (%)	-4.500000
SAR 10g (W/Kg)	0.056675
SAR 1g (W/Kg)	0.092161
<b>SURFACE SAR</b>	<b>VOLUME SAR</b>

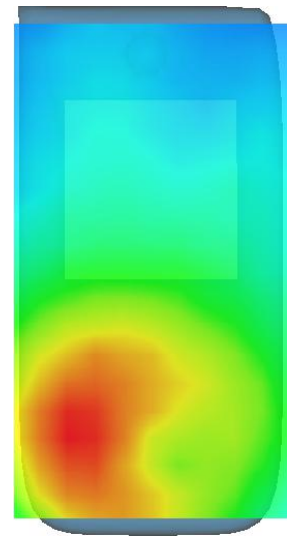
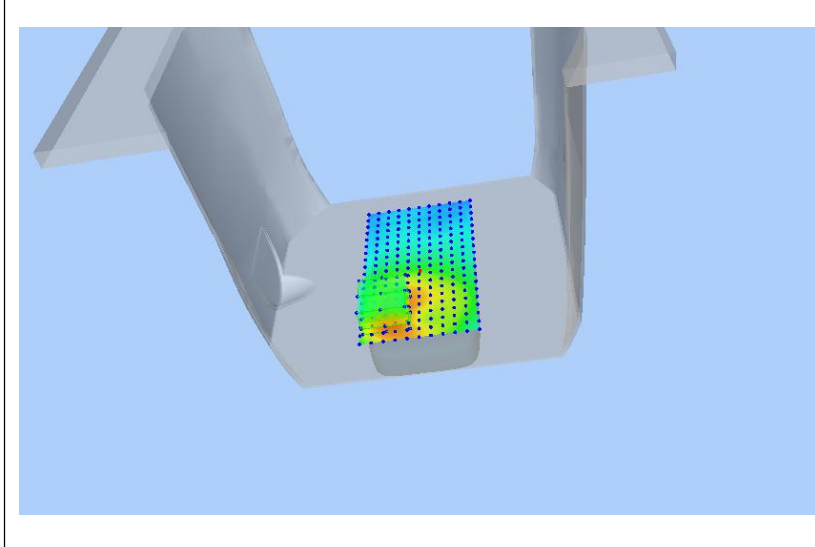
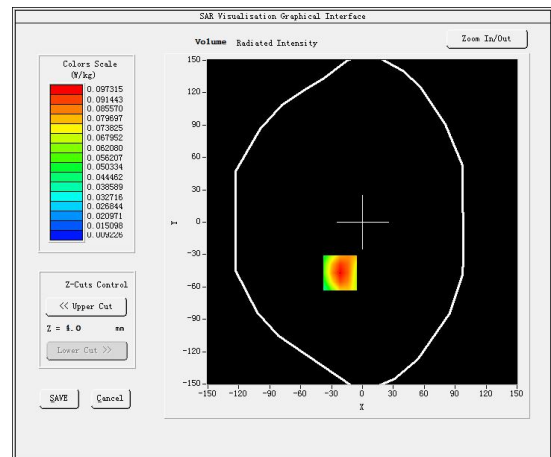
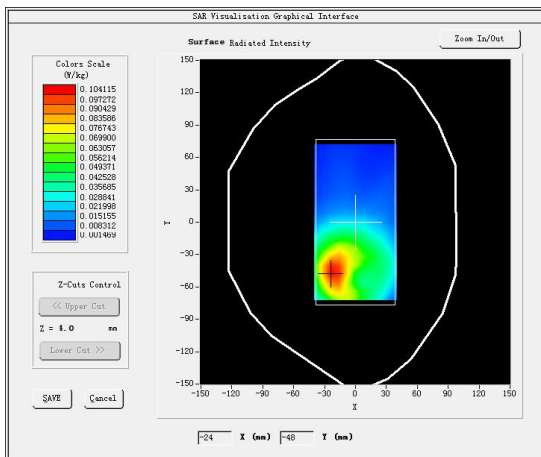

#3

Test Mode:GSM1800MHz,Middle channel(Left head cheek)

Product Description: mobile phone

Model:Librem 5

Test Date: April 30, 2021

Medium(liquid type)	HSL_1800
Frequency (MHz)	1747.4000
Relative permittivity (real part)	40.65
Conductivity (S/m)	1.42
E-Field Probe	SN 31/17 EPGO324
Crest Factor	8.0
Conversion Factor	1.65
Sensor	4mm
Area Scan	dx=8mm dy=8mm
Zoom Scan	5x5x7,dx=8mm dy=8mm dz=5mm
Variation (%)	2.700000
SAR 10g (W/Kg)	0.008697
SAR 1g (W/Kg)	0.016382

**SURFACE SAR**

**VOLUME SAR**

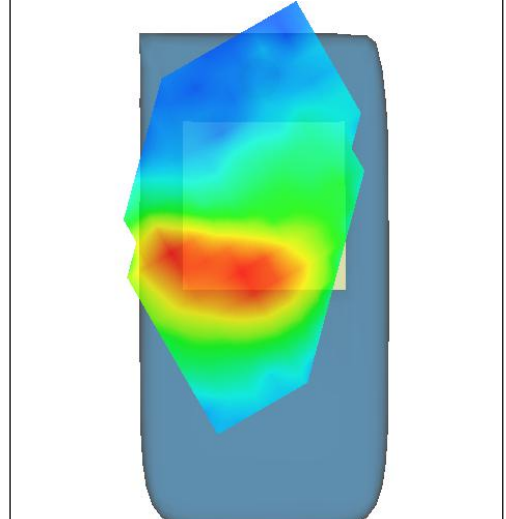
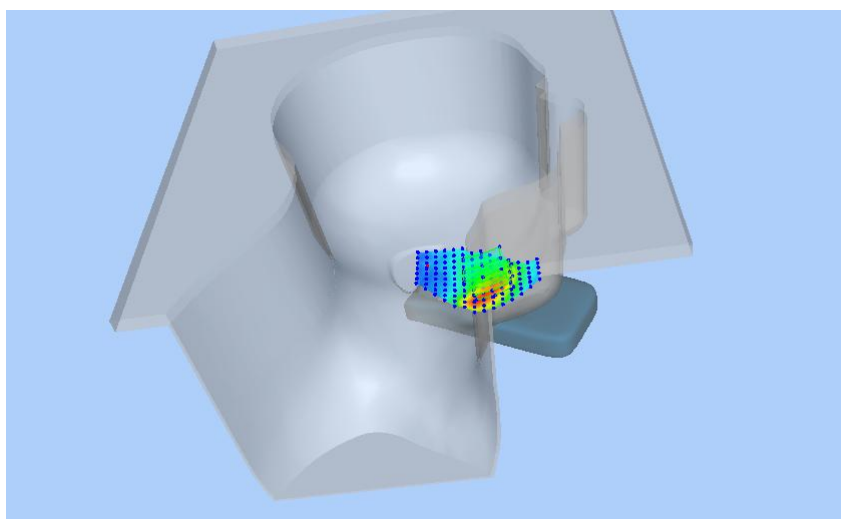
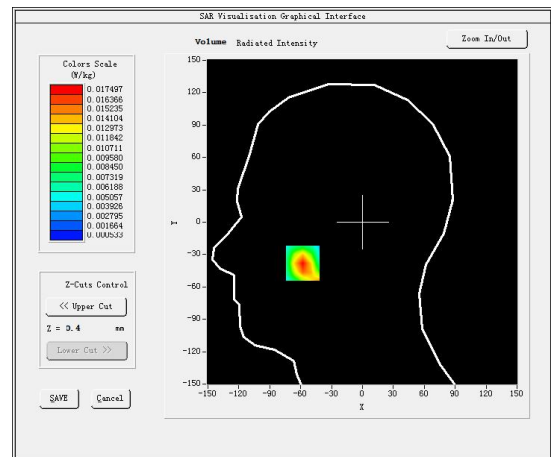
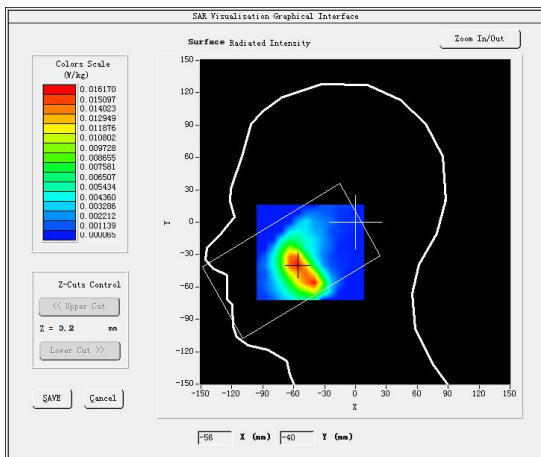

#4

Test Mode:GPRS1800MHz,Middle channel(Body-LCD Up)

Product Description: mobile phone

Model:Librem 5

Test Date: April 30, 2021

Medium(liquid type)	HSL_1800
Frequency (MHz)	1747.4000
Relative permittivity (real part)	40.66
Conductivity (S/m)	1.42
E-Field Probe	SN 31/17 EPGO324
Crest Factor	4.0
Conversion Factor	1.65
Sensor	4mm
Area Scan	dx=8mm dy=8mm
Zoom Scan	5x5x7,dx=8mm dy=8mm dz=5mm
Variation (%)	-4.000000
SAR 10g (W/Kg)	0.006521
SAR 1g (W/Kg)	0.011920

**SURFACE SAR**

**VOLUME SAR**

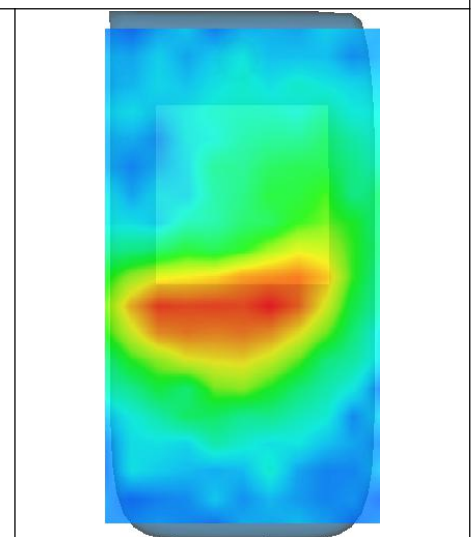
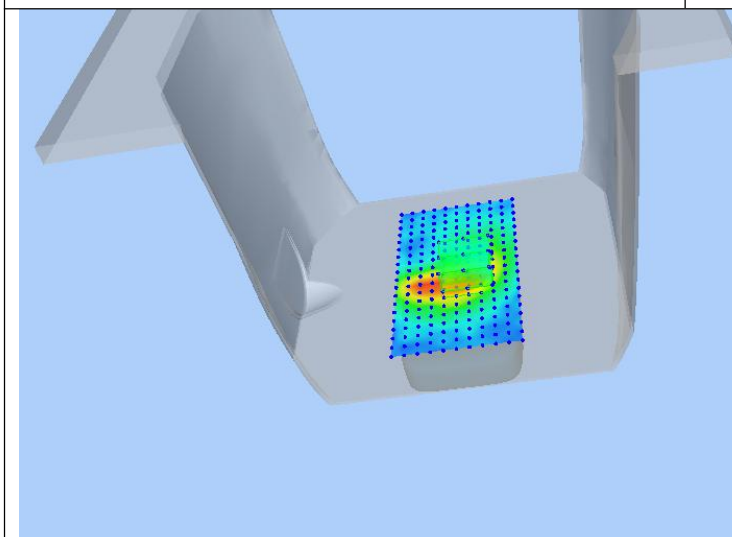
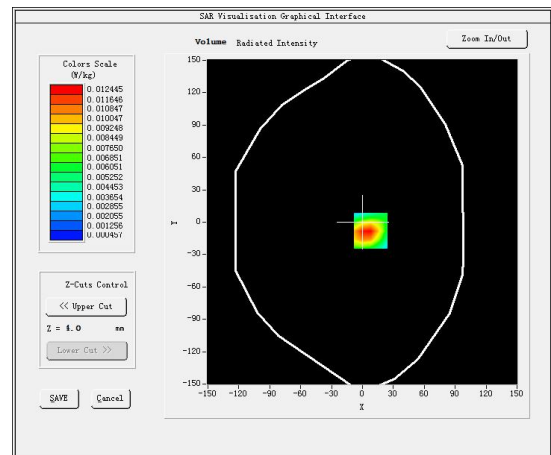
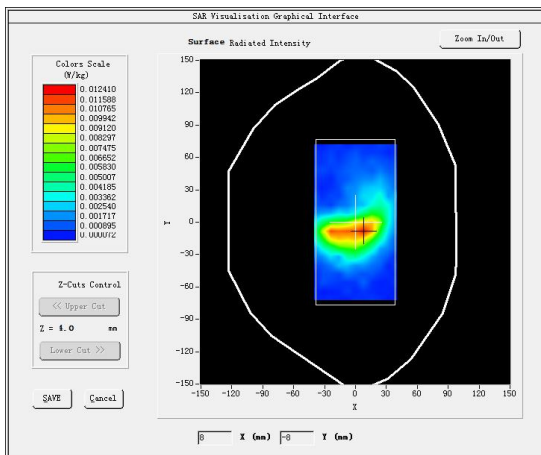

#5

Test Mode:WCDMA 900MHz,Middle channel(Left Head cheek)

Product Description: mobile phone

Model:Librem 5

Test Date: April 26, 2021

Medium(liquid type)	HSL_900
Frequency (MHz)	897.6000
Relative permittivity (real part)	42.55
Conductivity (S/m)	0.93
E-Field Probe	SN 31/17 EPGO324
Crest Factor	1.0
Conversion Factor	1.54
Sensor	4mm
Area Scan	dx=8mm dy=8mm
Zoom Scan	5x5x7,dx=8mm dy=8mm dz=5mm
Variation (%)	3.510000
SAR 10g (W/Kg)	0.615754
SAR 1g (W/Kg)	1.202872
<b>SURFACE SAR</b>	<b>VOLUME SAR</b>

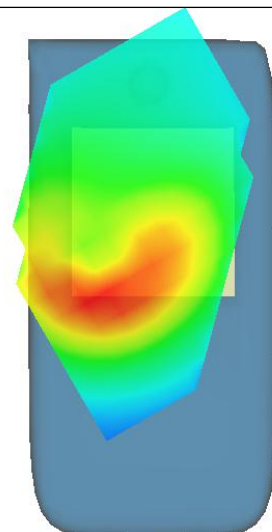
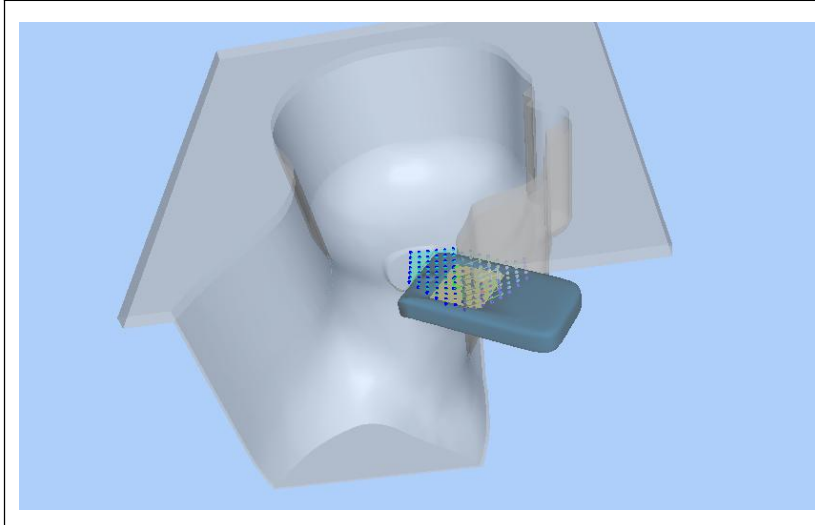
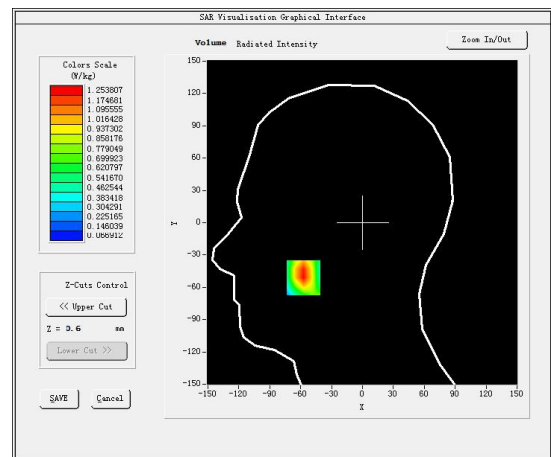
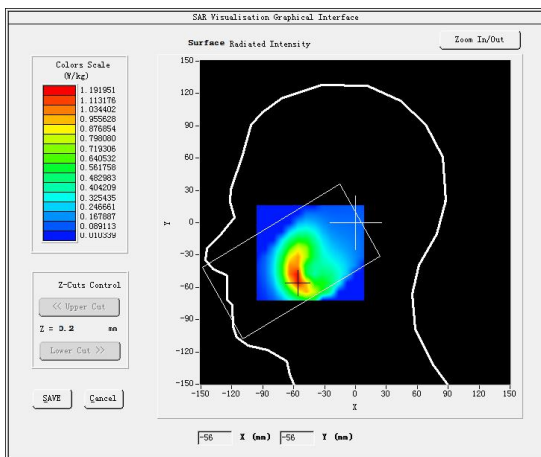

#6

Test Mode:WCDMA 900MHz,Middle channel(Body-LCD Down )

Product Description: mobile phone

Model:Librem 5

Test Date: April 26, 2021

Medium(liquid type)	HSL_900
Frequency (MHz)	897.6000
Relative permittivity (real part)	42.57
Conductivity (S/m)	0.93
E-Field Probe	SN 31/17 EPGO324
Crest Factor	1.0
Conversion Factor	1.54
Sensor	4mm
Area Scan	dx=8mm dy=8mm
Zoom Scan	5x5x7,dx=8mm dy=8mm dz=5mm
Variation (%)	1.550000
SAR 10g (W/Kg)	0.337417
SAR 1g (W/Kg)	0.557438

**SURFACE SAR**

**VOLUME SAR**

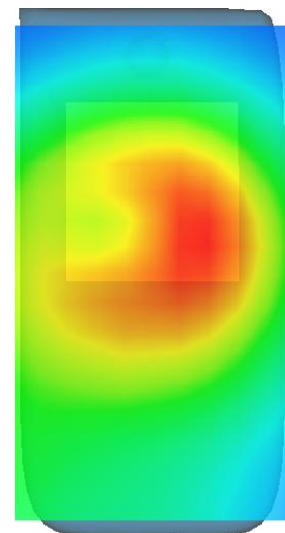
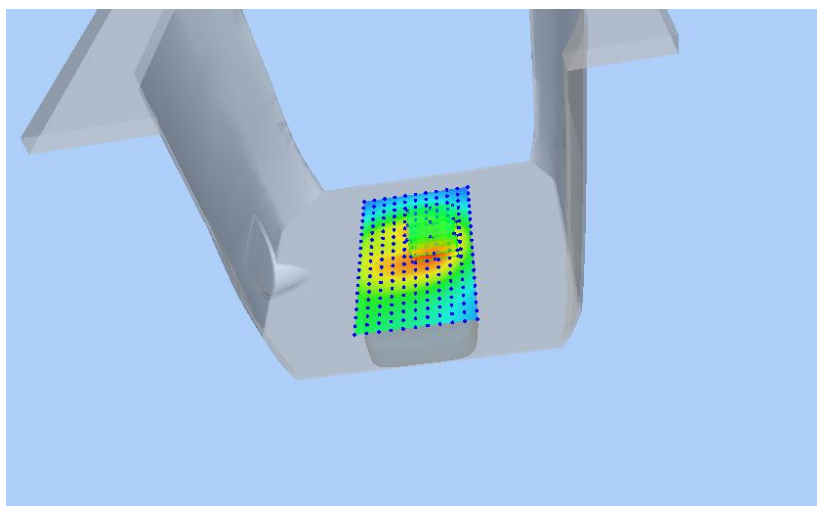
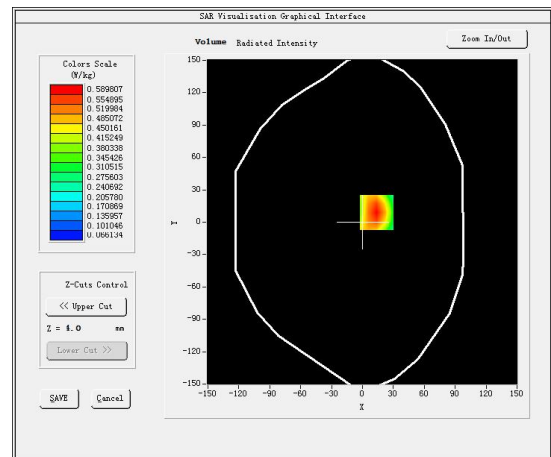
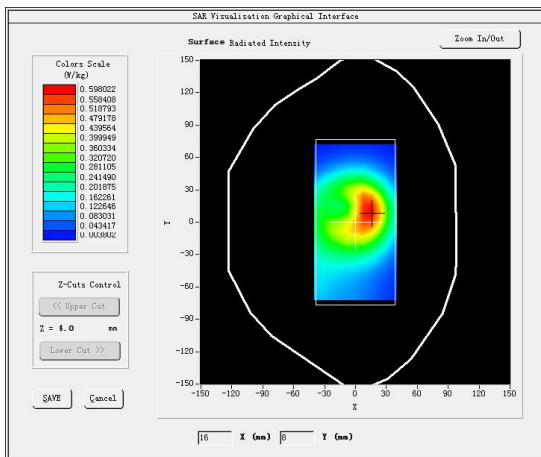

#7

Test Mode:WCDMA2100MHz,Middle channel(Left Head cheek)

Product Description: mobile phone

Model:Librem 5

Test Date: May 12, 2021

Medium(liquid type)	HSL_2000
Frequency (MHz)	1950.0000
Relative permittivity (real part)	39.20
Conductivity (S/m)	1.44
E-Field Probe	SN 31/17 EPGO324
Crest Factor	1.0
Conversion Factor	1.83
Sensor	4mm
Area Scan	dx=8mm dy=8mm
Zoom Scan	5x5x7,dx=8mm dy=8mm dz=5mm
Variation (%)	0.070000
SAR 10g (W/Kg)	0.228124
SAR 1g (W/Kg)	0.458476

**SURFACE SAR**

**VOLUME SAR**

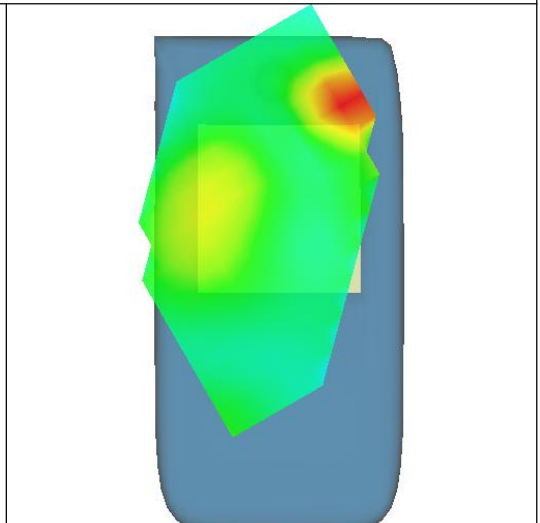
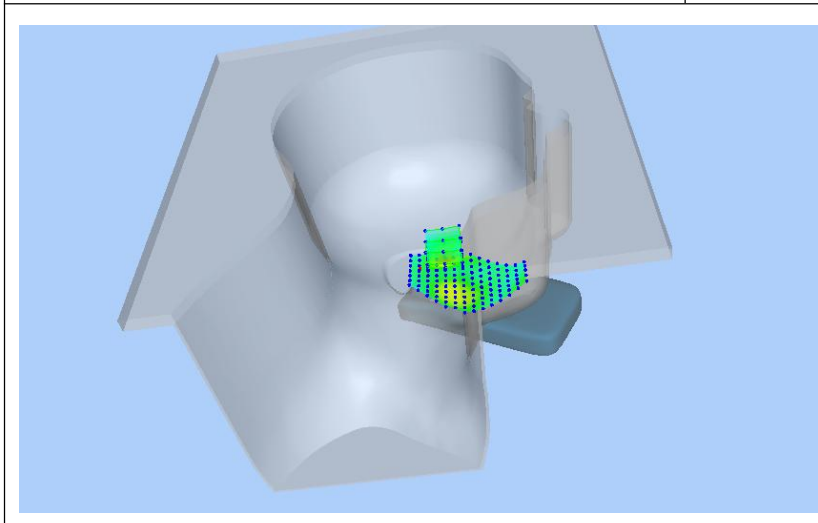
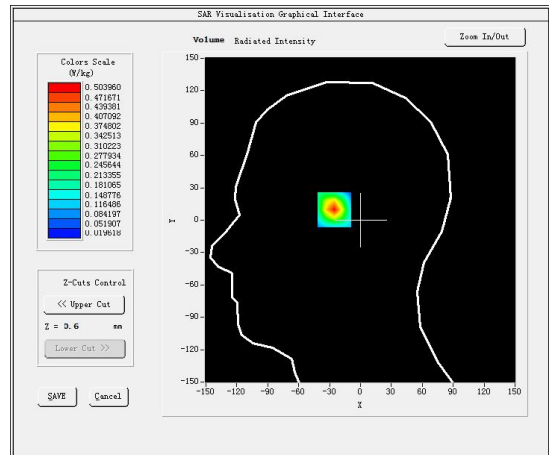
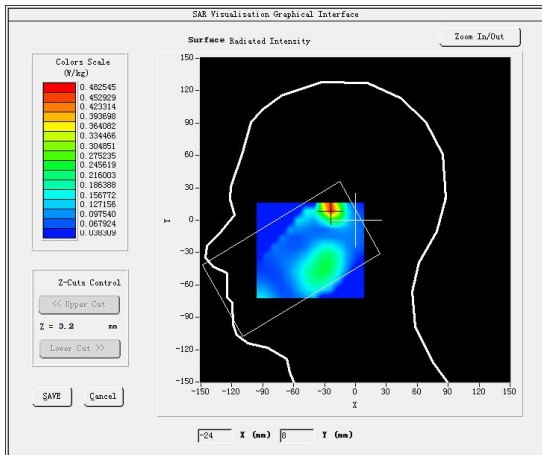

#8

Test Mode:WCDMA2100MHz,Middle channel(Body-LCD Up)

Product Description: mobile phone

Model:Librem 5

Test Date: May 12, 2021

Medium(liquid type)	HSL_2000
Frequency (MHz)	1950.0000
Relative permittivity (real part)	39.18
Conductivity (S/m)	1.43
E-Field Probe	SN 31/17 EPGO324
Crest Factor	1.0
Conversion Factor	1.83
Sensor	4mm
Area Scan	dx=8mm dy=8mm
Zoom Scan	5x5x7,dx=8mm dy=8mm dz=5mm
Variation (%)	-3.570000
SAR 10g (W/Kg)	0.506970
SAR 1g (W/Kg)	0.871675

**SURFACE SAR**

**VOLUME SAR**

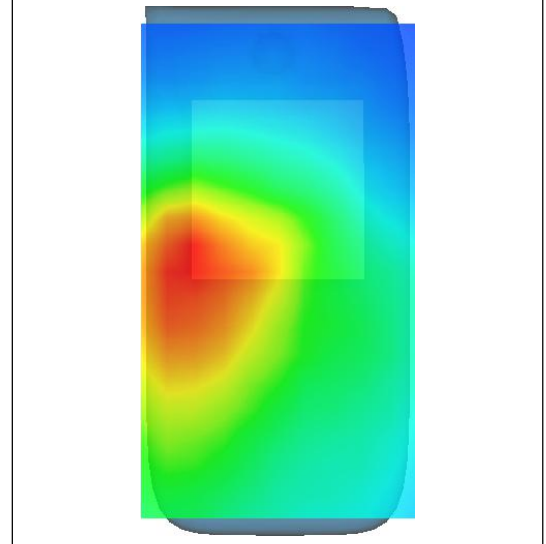
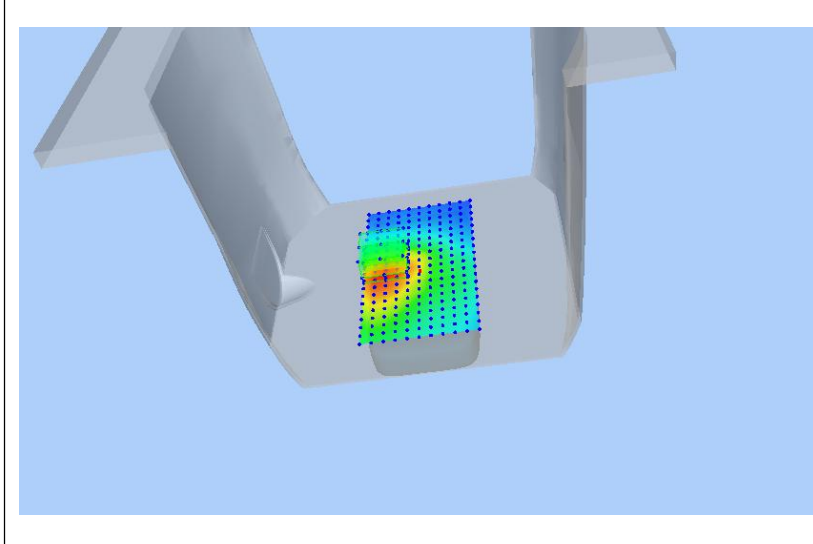
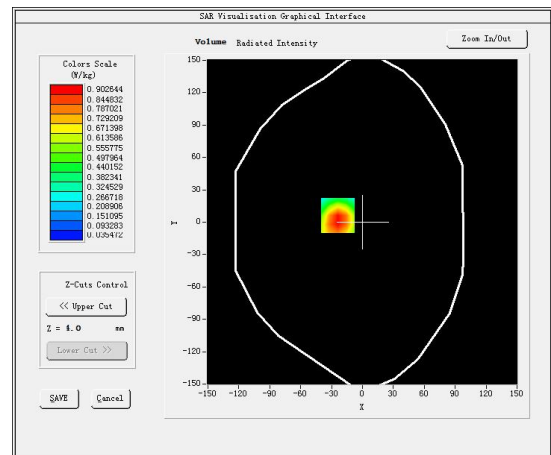
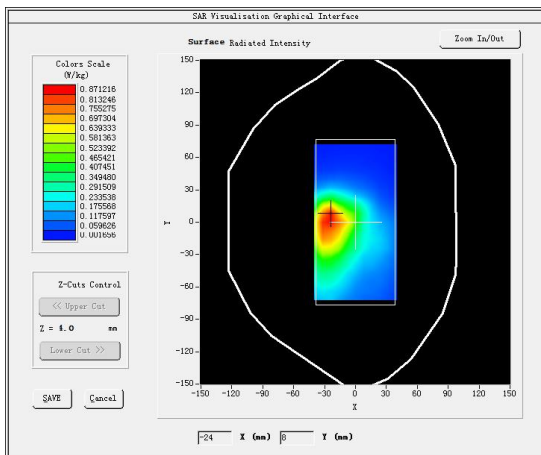

#9

Test Mode:802.11b,Middle channel(Left Head cheek)

Product Description: mobile phone

Model:Librem 5

Test Date: May 24, 2021

Medium(liquid type)	HSL_2450
Frequency (MHz)	2442.0000
Relative permittivity (real part)	38.38
Conductivity (S/m)	1.79
E-Field Probe	SN 31/17 EPGO324
Crest Factor	1.0
Conversion Factor	1.91
Sensor	4mm
Area Scan	dx=8mm dy=8mm
Zoom Scan	5x5x7,dx=8mm dy=8mm dz=5mm
Variation (%)	0.250000
SAR 10g (W/Kg)	0.172123
SAR 1g (W/Kg)	0.278520

**SURFACE SAR**

**VOLUME SAR**

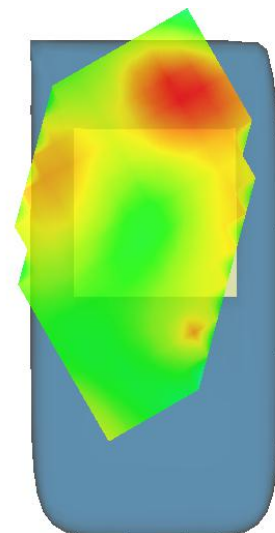
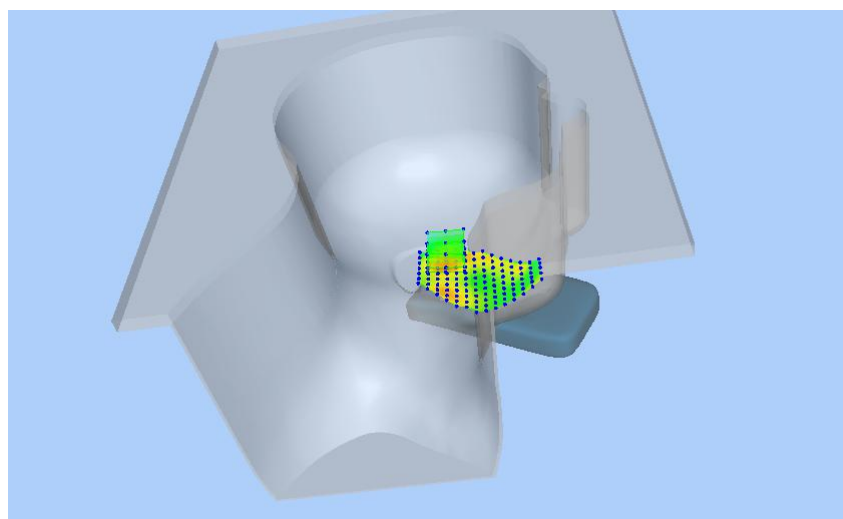
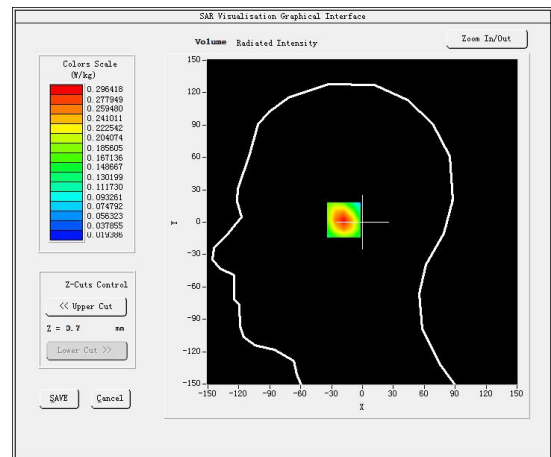
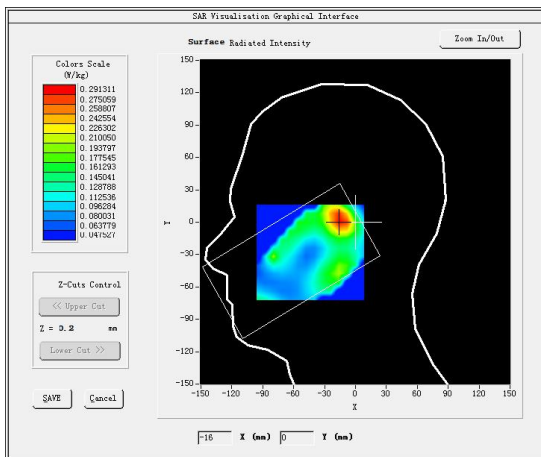



#10

Test Mode:802.11b,Middle channel(Body-LCD Down)

Product Description:mobile phone

Model:Librem 5

Test Date: May 24, 2021

Medium(liquid type)	HSL_2450
Frequency (MHz)	2442.0000
Relative permittivity (real part)	38.33
Conductivity (S/m)	1.76
E-Field Probe	SN 31/17 EPGO324
Crest Factor	1.0
Conversion Factor	1.91
Sensor	4mm
Area Scan	dx=8mm dy=8mm
Zoom Scan	5x5x7,dx=8mm dy=8mm dz=5mm
Variation (%)	0.350000
SAR 10g (W/Kg)	0.292410
SAR 1g (W/Kg)	0.419609

**SURFACE SAR**

**VOLUME SAR**

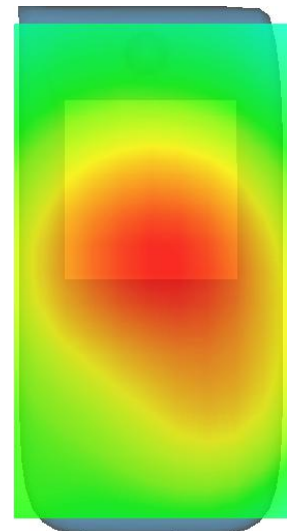
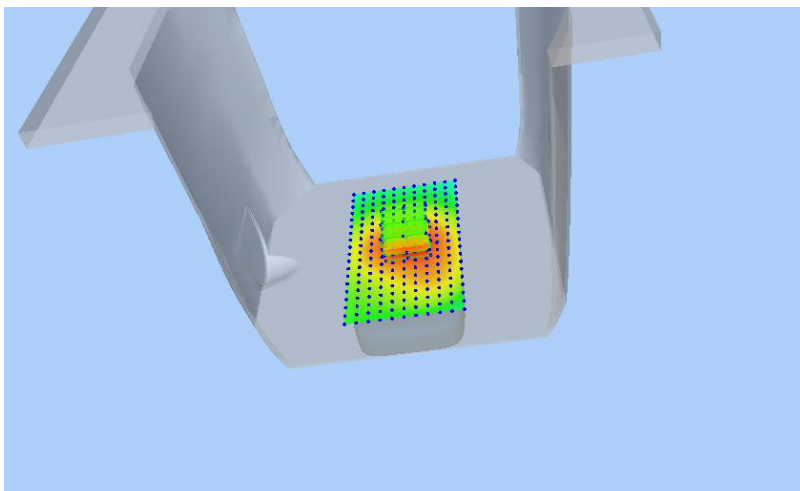
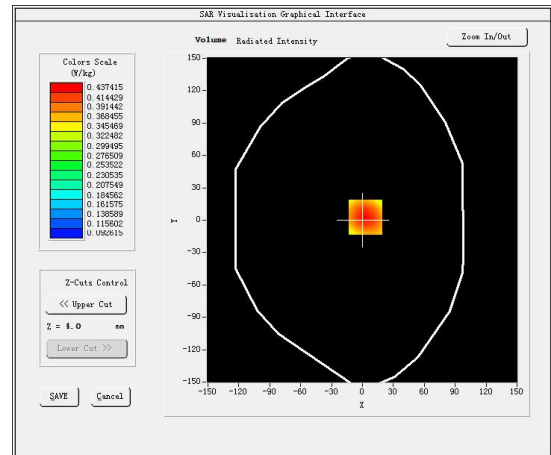
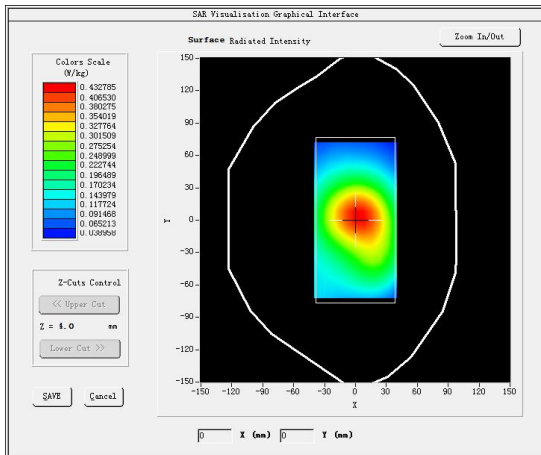

#11

Test Mode:802.11a(WiFi5.2G),Middle channel(Left Head cheek)

Product Description: mobile phone

Model:Librem 5

Test Date: June 15, 2021

Medium(liquid type)	MSL_5000
Frequency (MHz)	5210.0000
Relative permittivity (real part)	35.80
Conductivity (S/m)	4.57
E-Field Probe	SN 31/17 EPGO324
Crest Factor	1.0
Conversion Factor	1.50
Sensor	4mm
Area Scan	dx=8mm dy=8mm
Zoom Scan	5x5x7,dx=8mm dy=8mm dz=5mm
Variation (%)	3.780000
SAR 10g (W/Kg)	0.218608
SAR 1g (W/Kg)	0.409556

**SURFACE SAR**

**VOLUME SAR**

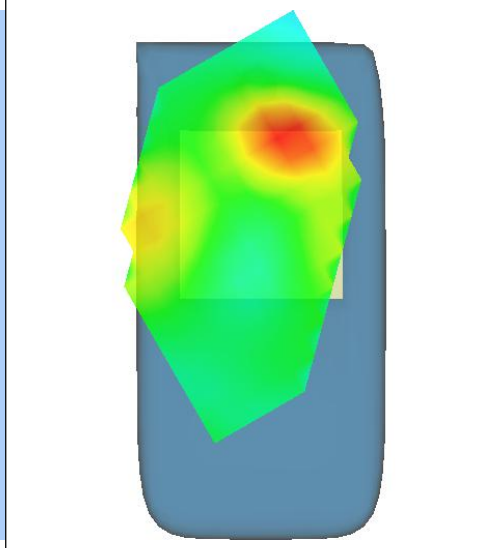
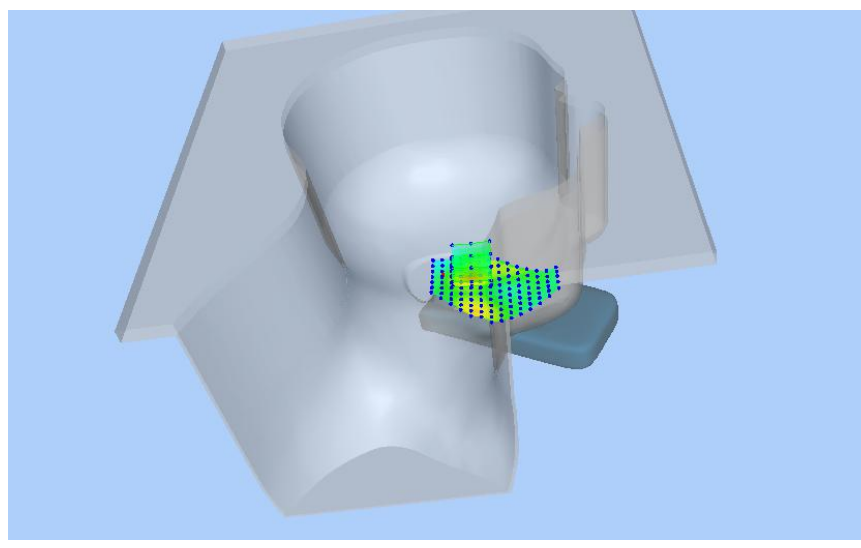
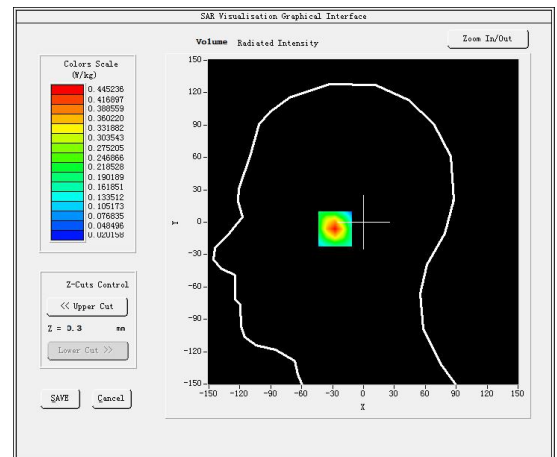
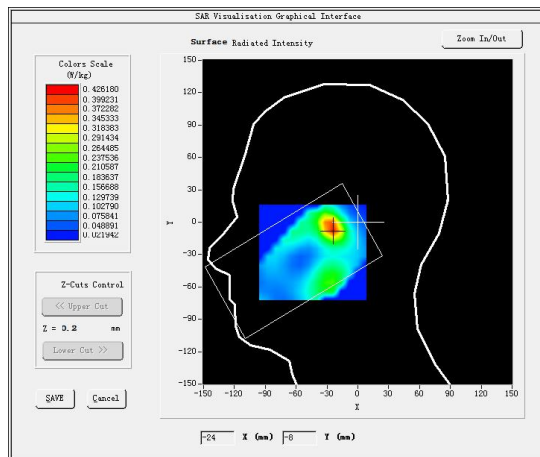

#12

Test Mode:802.11a(WiFi5.2G),Middle channel(Body-LCD Down)

Product Description: mobile phone

Model:Librem 5

Test Date: June 15, 2021

Medium(liquid type)	MSL_5000
Frequency (MHz)	5210.0000
Relative permittivity (real part)	35.80
Conductivity (S/m)	4.57
E-Field Probe	SN 31/17 EPGO324
Crest Factor	1.0
Conversion Factor	1.50
Sensor	4mm
Area Scan	dx=8mm dy=8mm
Zoom Scan	5x5x7,dx=8mm dy=8mm dz=5mm
Variation (%)	0.290000
SAR 10g (W/Kg)	0.268119
SAR 1g (W/Kg)	0.403013

**SURFACE SAR**

**VOLUME SAR**

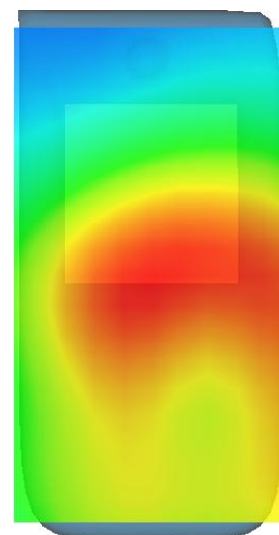
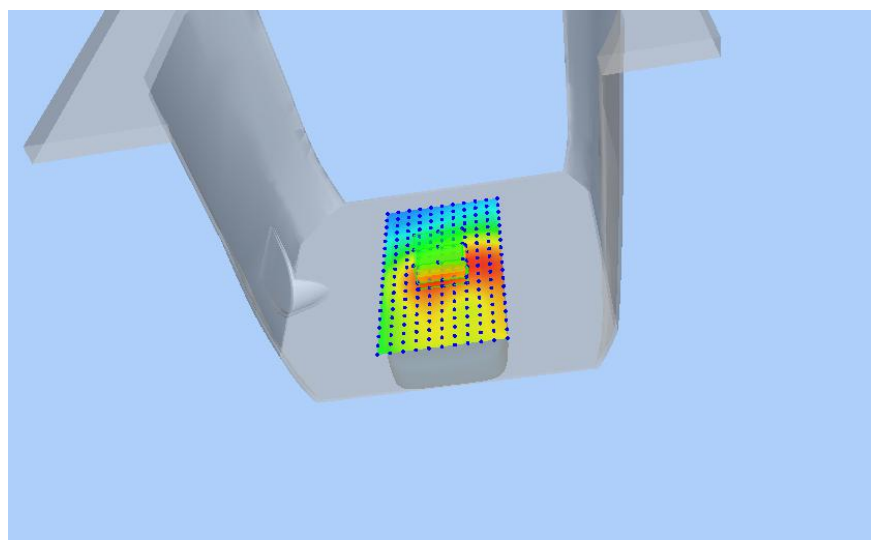
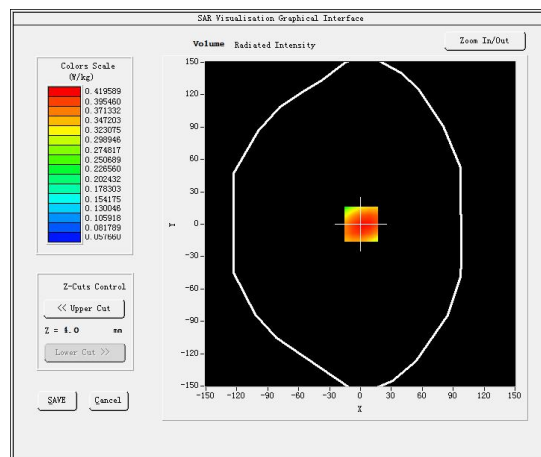
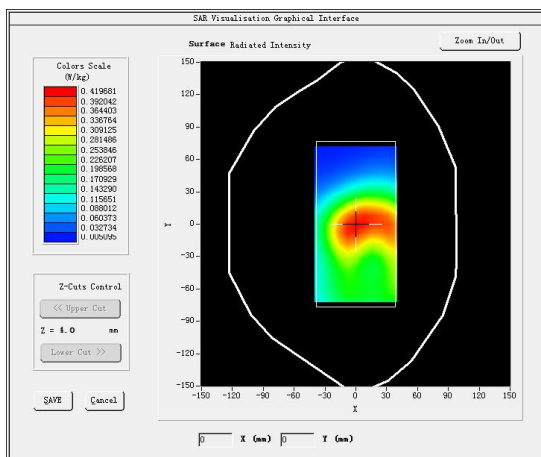

#13

Test Mode: 802.11a(WiFi5.8G), Middle channel (Left Head cheek)

Product Description: mobile phone

Model:Librem 5

Test Date: June 15, 2021

Medium(liquid type)	MSL_5000
Frequency (MHz)	5755.0000
Relative permittivity (real part)	35.83
Conductivity (S/m)	4.61
E-Field Probe	SN 31/17 EPGO324
Crest Factor	1.0
Conversion Factor	1.50
Sensor	4mm
Area Scan	dx=8mm dy=8mm
Zoom Scan	5x5x7,dx=8mm dy=8mm dz=5mm
Variation (%)	1.430000
SAR 10g (W/Kg)	0.247617
SAR 1g (W/Kg)	0.491627
<b>SURFACE SAR</b>	<b>VOLUME SAR</b>

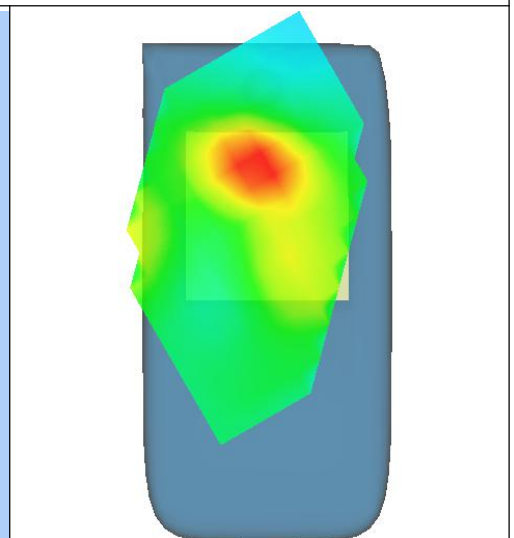
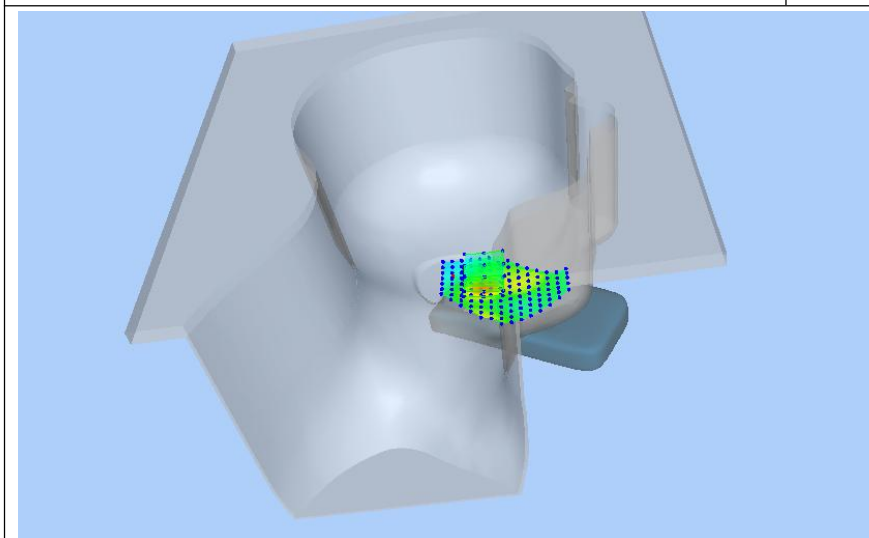
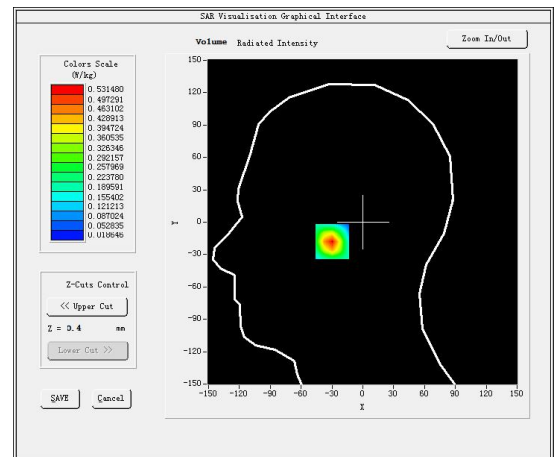
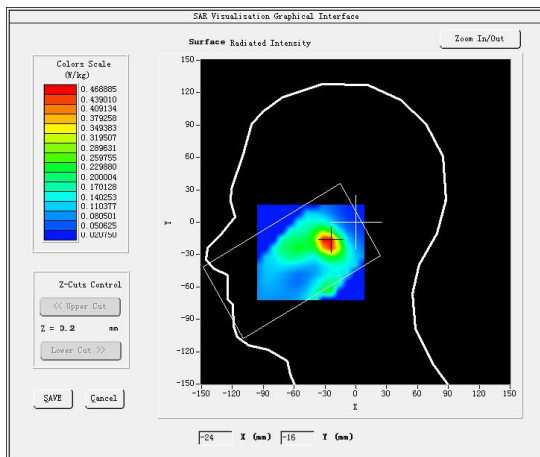

#14

Test Mode: 802.11a(WiFi5.8G), Middle channel (Body-LCD Down)

Product Description: mobile phone

Model:Librem 5

Test Date: June 15, 2021

Medium(liquid type)	MSL_5000
Frequency (MHz)	5755.0000
Relative permittivity (real part)	35.83
Conductivity (S/m)	4.61
E-Field Probe	SN 31/17 EPGO324
Crest Factor	1.0
Conversion Factor	1.50
Sensor	4mm
Area Scan	dx=8mm dy=8mm
Zoom Scan	5x5x7,dx=8mm dy=8mm dz=5mm
Variation (%)	0.950000
SAR 10g (W/Kg)	0.360669
SAR 1g (W/Kg)	0.521759

**SURFACE SAR**

**VOLUME SAR**

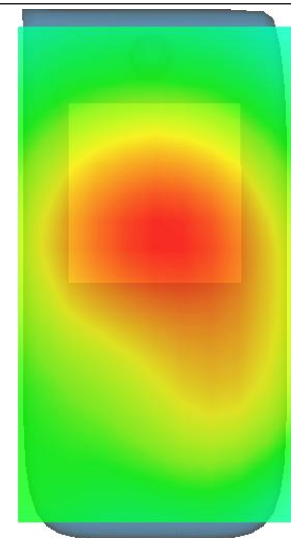
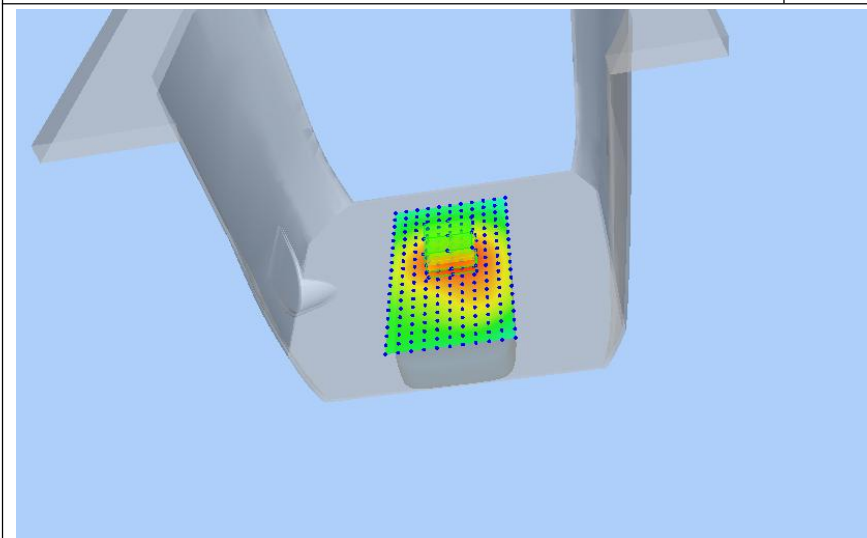
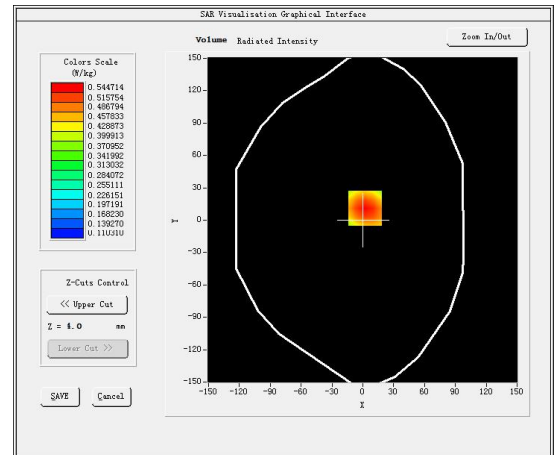
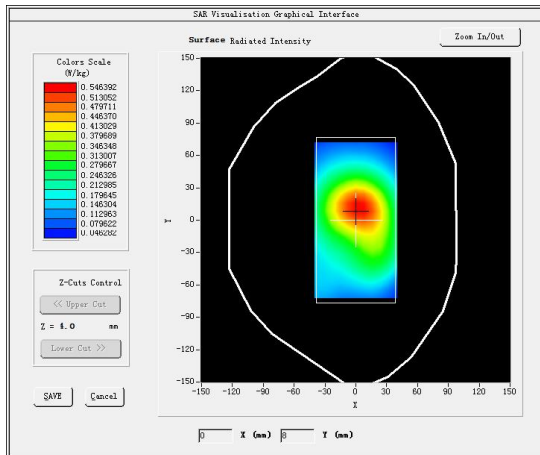

#15

Test Mode:E-UTRA Band1,Middle channel(Left Head cheek)

Product Description: mobile phone

Model:Librem 5

Test Date: May 12, 2021

Medium(liquid type)	HSL_2000
Frequency (MHz)	1950.0000
Relative permittivity (real part)	39.18
Conductivity (S/m)	1.43
E-Field Probe	SN 31/17 EPG0324
Crest Factor	1.0
Conversion Factor	1.83
Sensor	4mm
Area Scan	dx=8mm dy=8mm
Zoom Scan	5x5x7,dx=8mm dy=8mm dz=5mm
Variation (%)	-0.440000
SAR 10g (W/Kg)	0.095857
SAR 1g (W/Kg)	0.161933

**SURFACE SAR**

**VOLUME SAR**

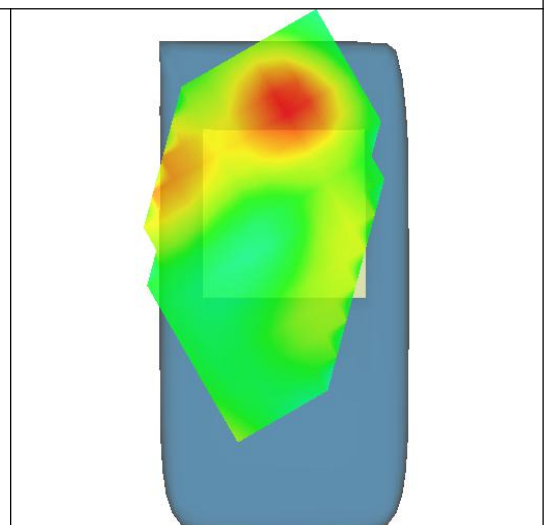
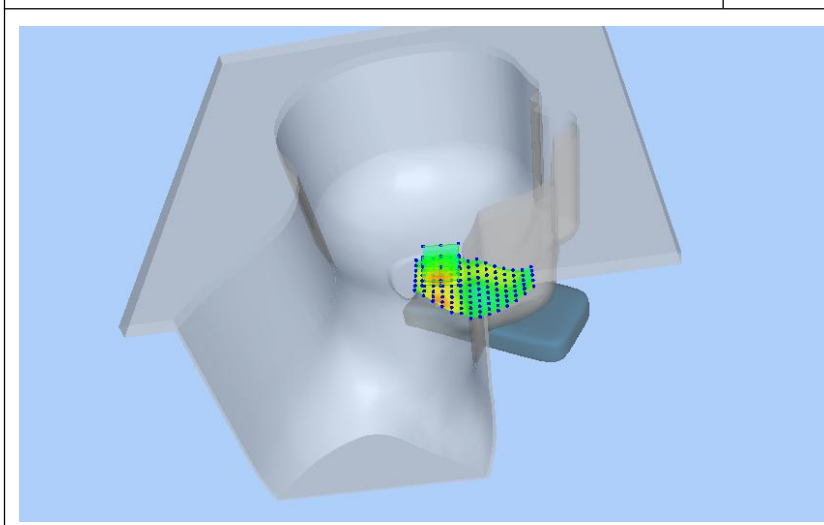
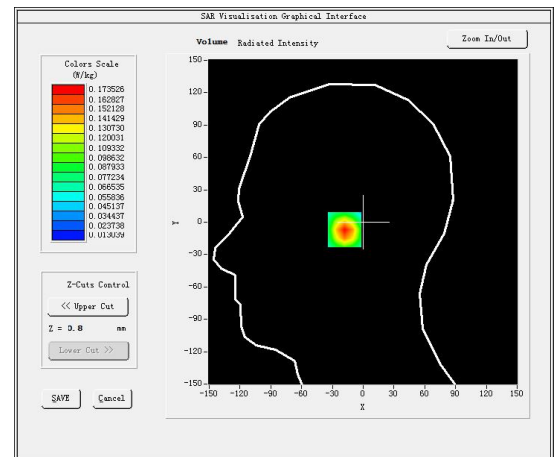
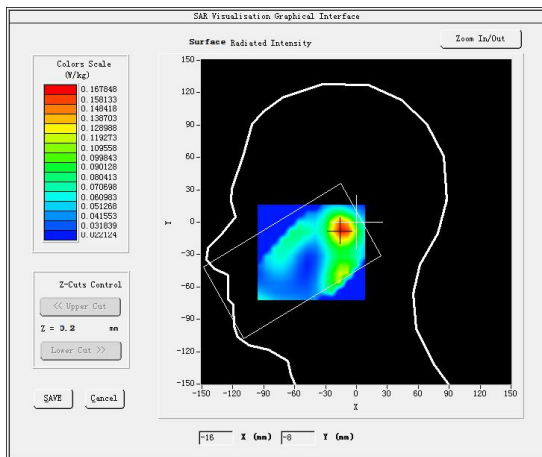

#16

Test Mode: E-UTRA Band1,Middle channel(Body-LCD Up)

Product Description: mobile phone

Model:Librem 5

Test Date: May 12, 2021

Medium(liquid type)	HSL_2000
Frequency (MHz)	1950.0000
Relative permittivity (real part)	39.19
Conductivity (S/m)	1.40
E-Field Probe	SN 31/17 EPGO324
Crest Factor	1.0
Conversion Factor	1.83
Sensor	4mm
Area Scan	dx=8mm dy=8mm
Zoom Scan	5x5x7,dx=8mm dy=8mm dz=5mm
Variation (%)	-1.070000
SAR 10g (W/Kg)	0.426562
SAR 1g (W/Kg)	0.618483

**SURFACE SAR**

**VOLUME SAR**

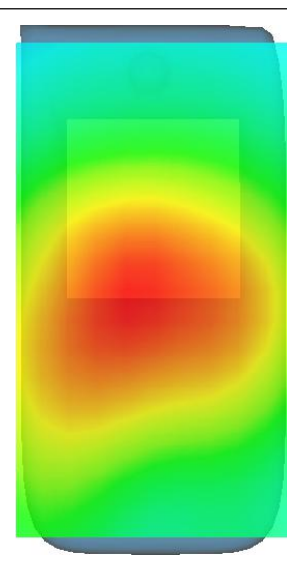
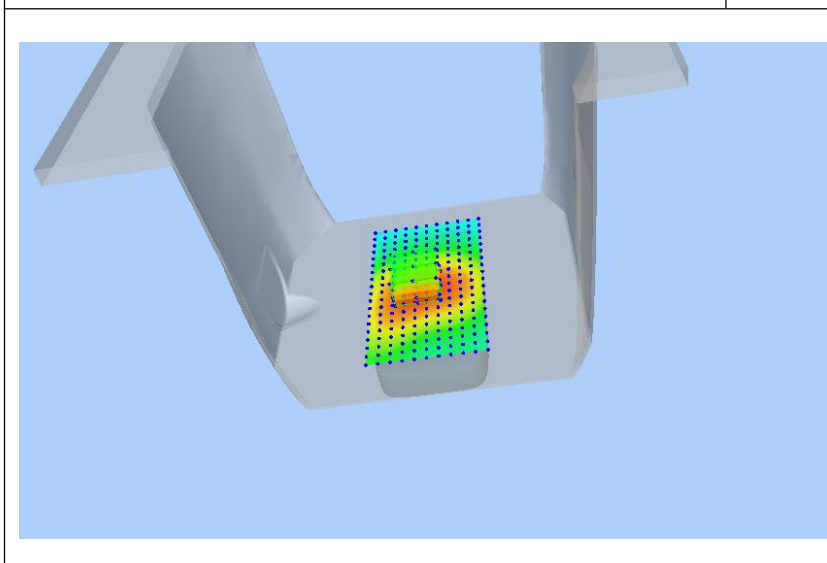
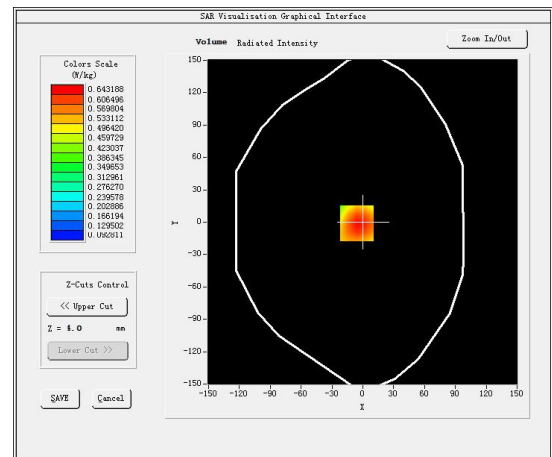
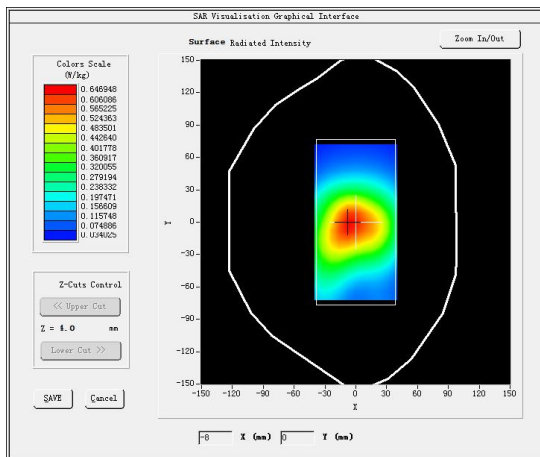

#17

Test Mode:E-UTRA3,Middle channel(Left head cheek)

Product Description: mobile phone

Model:Librem 5

Test Date: April 30, 2021

Medium(liquid type)	HSL_1800
Frequency (MHz)	1747.5000
Relative permittivity (real part)	40.65
Conductivity (S/m)	1.42
E-Field Probe	SN 31/17 EPGO324
Crest Factor	1.0
Conversion Factor	1.65
Sensor	4mm
Area Scan	dx=8mm dy=8mm
Zoom Scan	5x5x7,dx=8mm dy=8mm dz=5mm
Variation (%)	3.260000
SAR 10g (W/Kg)	0.082962
SAR 1g (W/Kg)	0.123000

**SURFACE SAR**

**VOLUME SAR**

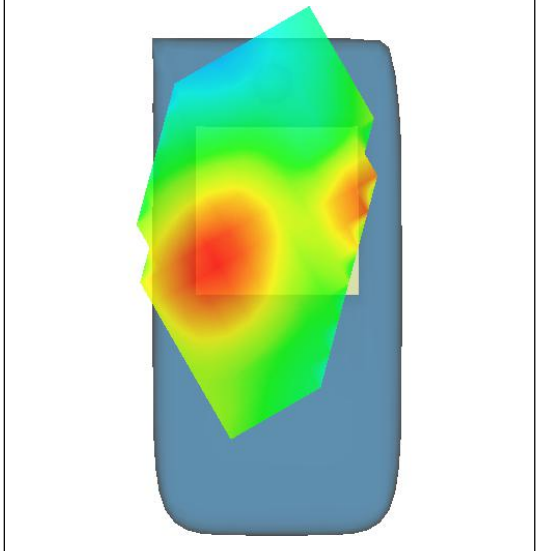
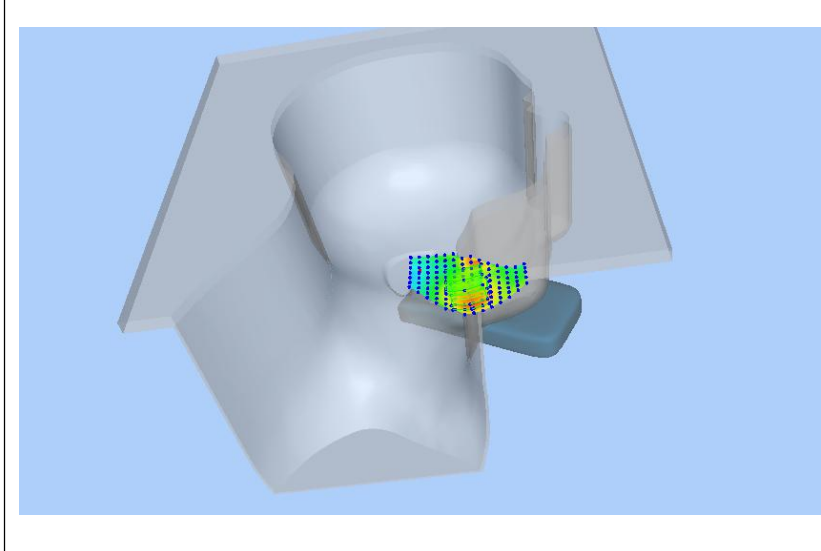
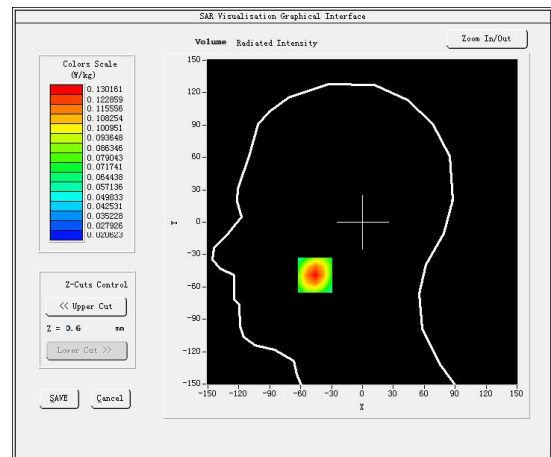
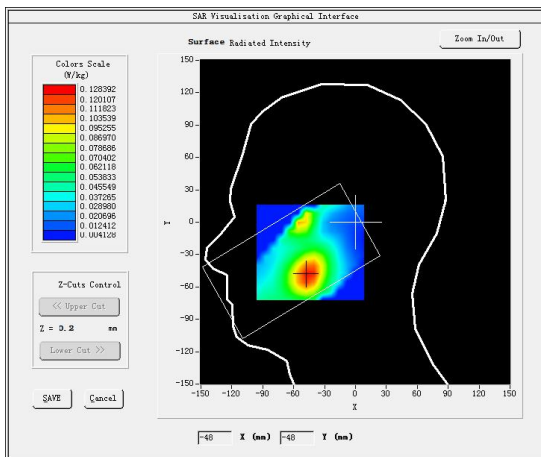



#18

Test Mode: E-UTRA3,Middle channel(Body-LCD Down)

Product Description: mobile phone

Model:Librem 5

Test Date: April 30, 2021

Medium(liquid type)	HSL_1800
Frequency (MHz)	1747.5000
Relative permittivity (real part)	40.67
Conductivity (S/m)	1.45
E-Field Probe	SN 31/17 EPGO324
Crest Factor	1.0
Conversion Factor	1.65
Sensor	4mm
Area Scan	dx=8mm dy=8mm
Zoom Scan	5x5x7,dx=8mm dy=8mm dz=5mm
Variation (%)	1.160000
SAR 10g (W/Kg)	1.020131
SAR 1g (W/Kg)	1.801295

**SURFACE SAR**

**VOLUME SAR**

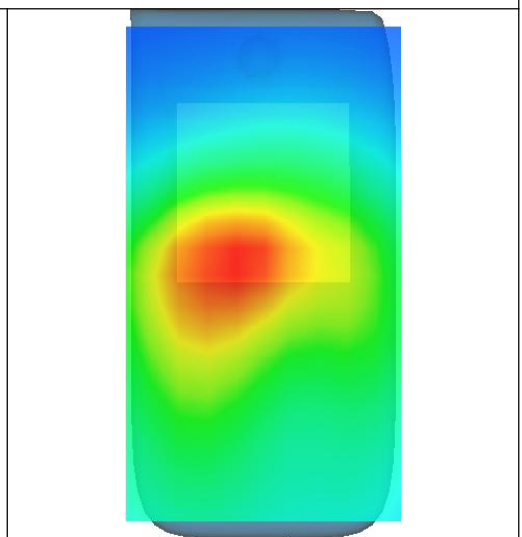
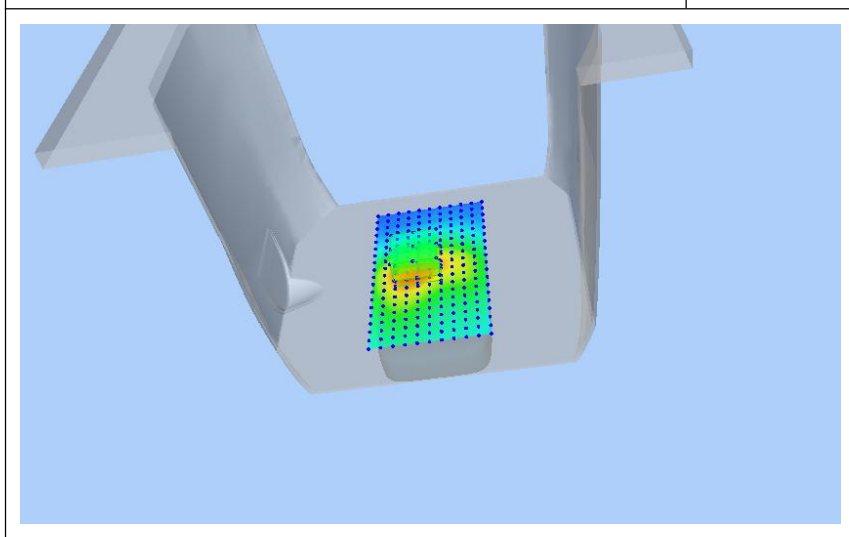
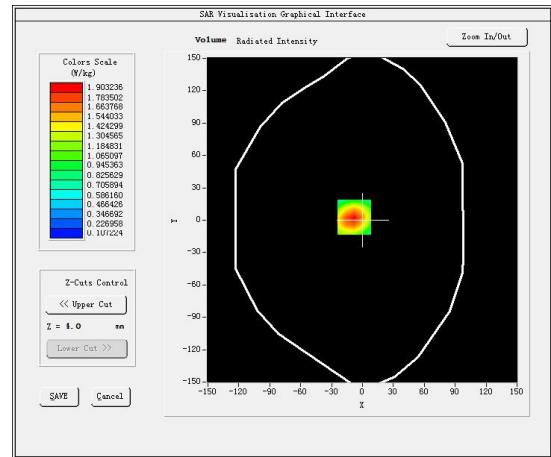
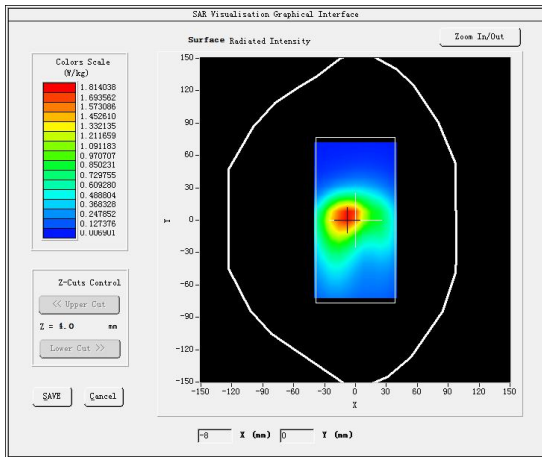

#19

Test Mode: E-UTRA7,Middle channel(Left head cheek)

Product Description: mobile phone

Model:Librem 5

Test Date: May 30, 2021

Medium(liquid type)	HSL_2600
Frequency (MHz)	2535.0000
Relative permittivity (real part)	40.37
Conductivity (S/m)	1.91
E-Field Probe	SN 31/17 EPGO324
Crest Factor	1.0
Conversion Factor	1.89
Sensor	4mm
Area Scan	dx=8mm dy=8mm
Zoom Scan	5x5x7,dx=8mm dy=8mm dz=5mm
Variation (%)	-1.380000
SAR 10g (W/Kg)	0.072325
SAR 1g (W/Kg)	0.112817

**SURFACE SAR**

**VOLUME SAR**

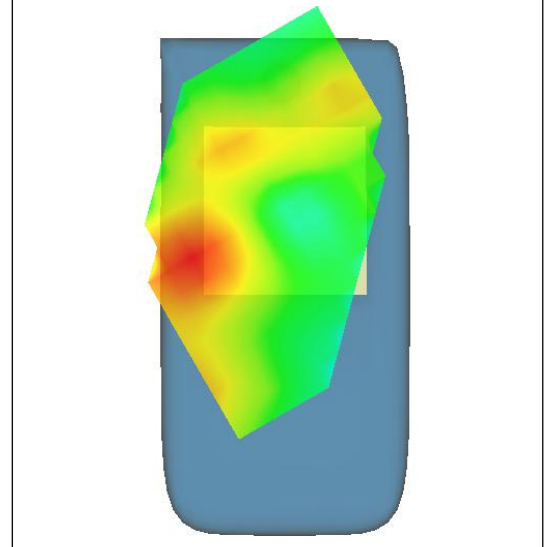
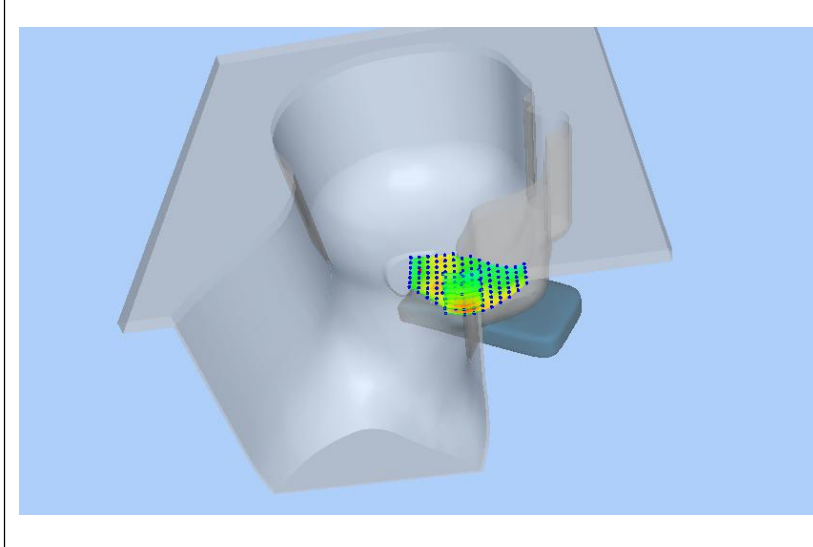
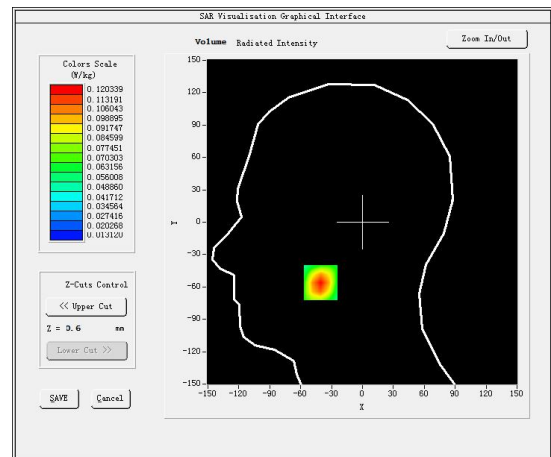
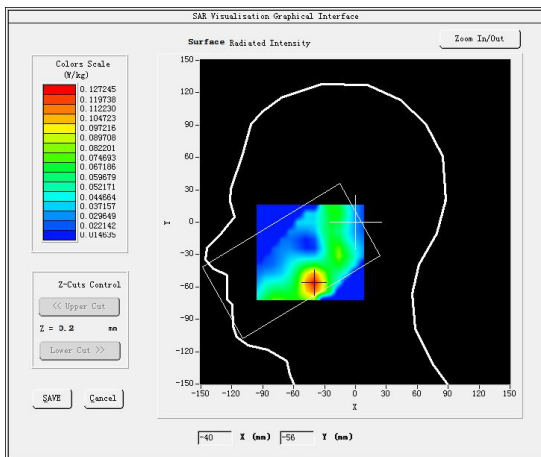

#20

Test Mode: E-UTRA7,Middle channel(Body-LCD Down)

Product Description: mobile phone

Model:Librem 5

Test Date: May 30, 2021

Medium(liquid type)	HSL_2600
Frequency (MHz)	2535.0000
Relative permittivity (real part)	40.38
Conductivity (S/m)	1.92
E-Field Probe	SN 31/17 EPGO324
Crest Factor	1.0
Conversion Factor	1.89
Sensor	4mm
Area Scan	dx=8mm dy=8mm
Zoom Scan	5x5x7,dx=8mm dy=8mm dz=5mm
Variation (%)	4.480000
SAR 10g (W/Kg)	1.006189
SAR 1g (W/Kg)	1.868760

**SURFACE SAR**

**VOLUME SAR**

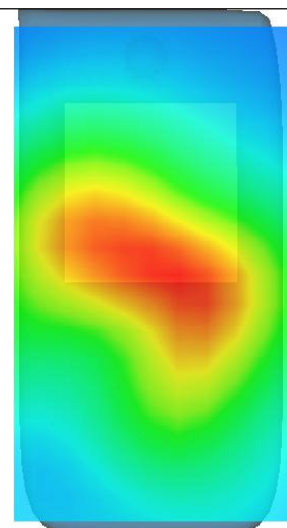
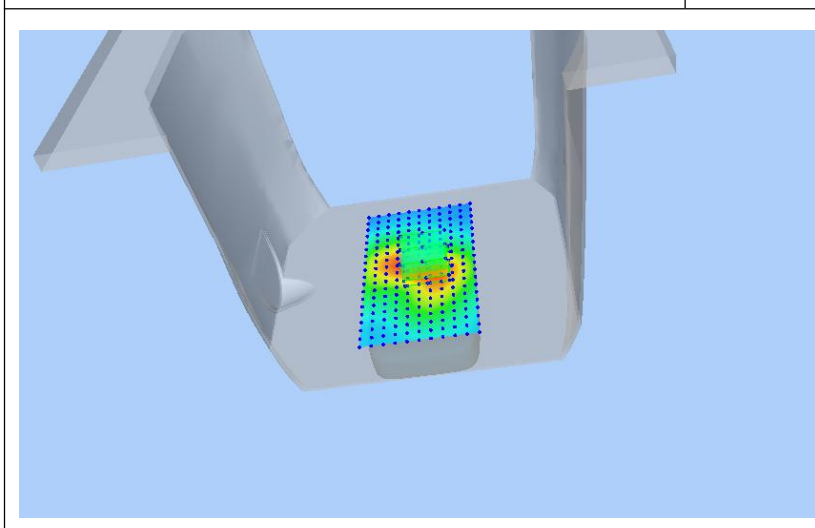
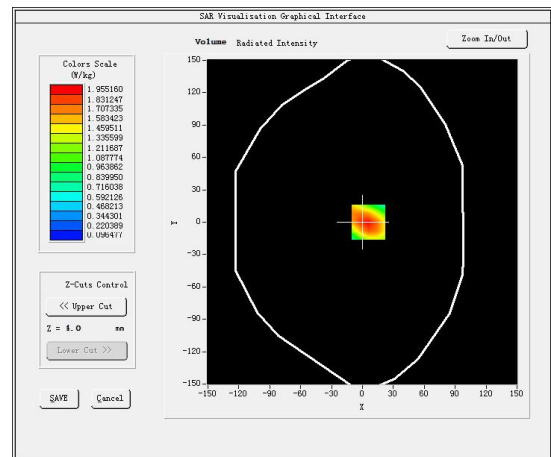
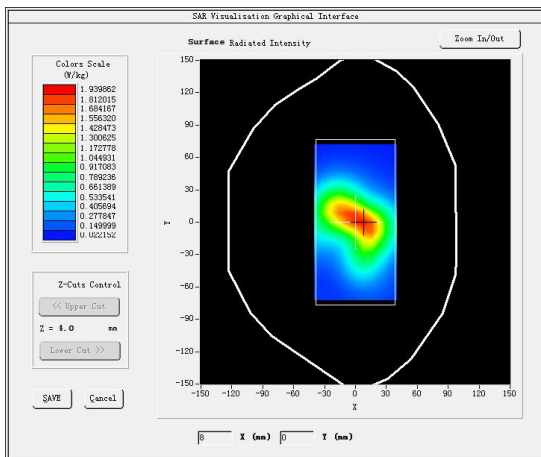

#21

Test Mode: E-UTRA8,Middle channel(Right head cheek)

Product Description: mobile phone

Model:Librem 5

Test Date: April 26, 2021

Medium(liquid type)	HSL_900
Frequency (MHz)	897.5000
Relative permittivity (real part)	42.52
Conductivity (S/m)	0.93
E-Field Probe	SN 31/17 EPGO324
Crest Factor	1.0
Conversion Factor	1.54
Sensor	4mm
Area Scan	dx=8mm dy=8mm
Zoom Scan	5x5x7,dx=8mm dy=8mm dz=5mm
Variation (%)	-1.390000
SAR 10g (W/Kg)	0.592702
SAR 1g (W/Kg)	1.160508

**SURFACE SAR**

**VOLUME SAR**

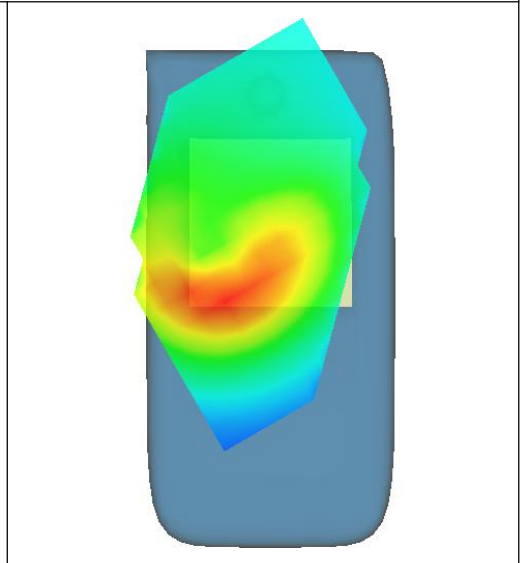
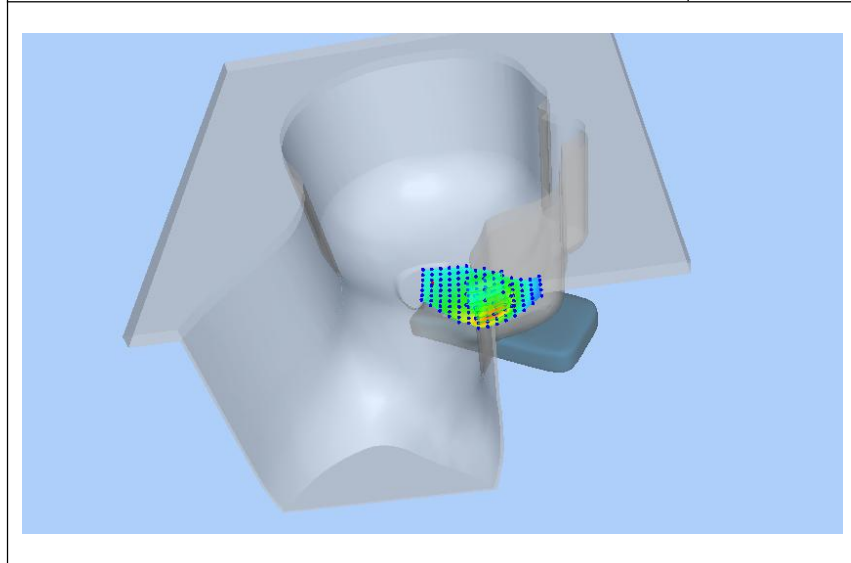
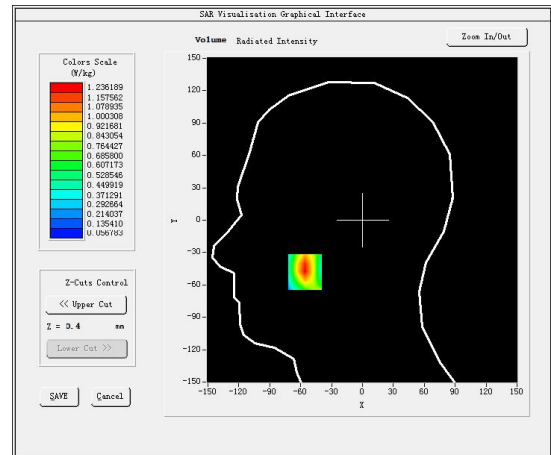
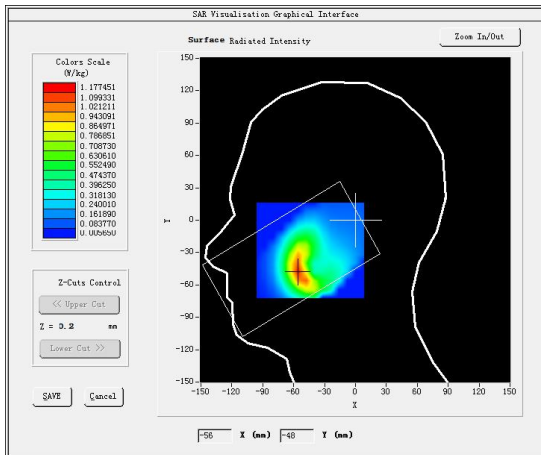

#22

Test Mode: E-UTRA8, Middle channel (Body-LCD Down)

Product Description: mobile phone

Model: Librem 5

Test Date: April 26, 2021

Medium (liquid type)	HSL_900
Frequency (MHz)	897.5000
Relative permittivity (real part)	42.52
Conductivity (S/m)	0.95
E-Field Probe	SN 31/17 EPGO324
Crest Factor	1.0
Conversion Factor	1.54
Sensor	4mm
Area Scan	dx=8mm dy=8mm
Zoom Scan	5x5x7, dx=8mm dy=8mm dz=5mm
Variation (%)	0.560000
SAR 10g (W/Kg)	0.109443
SAR 1g (W/Kg)	0.142576

**SURFACE SAR**

**VOLUME SAR**

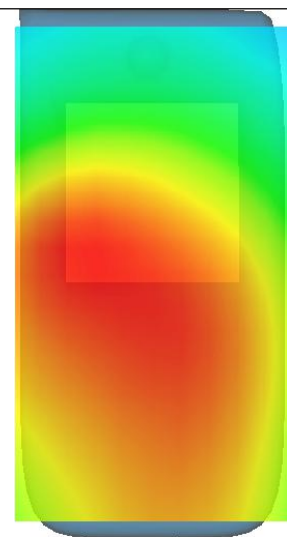
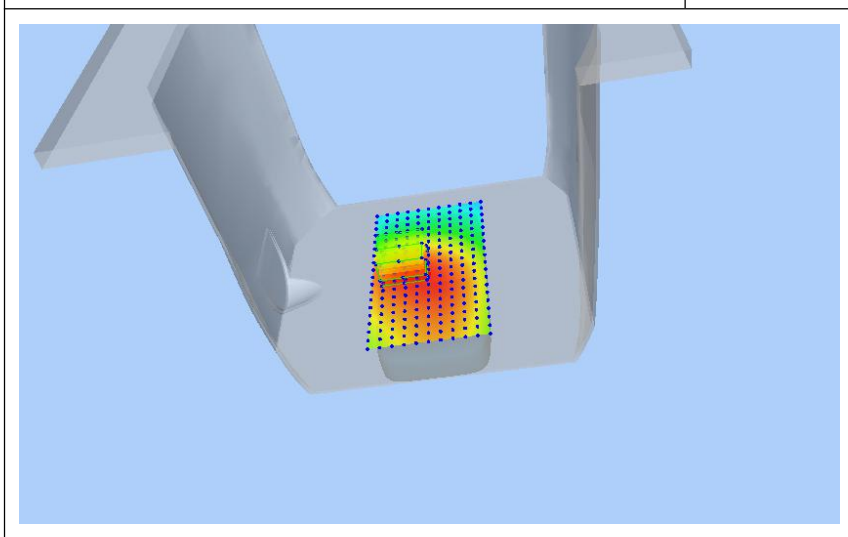
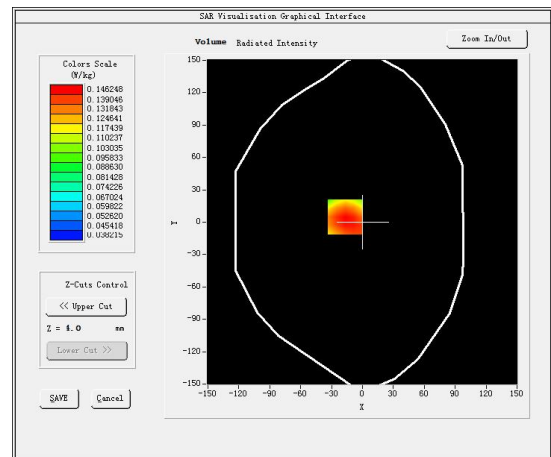
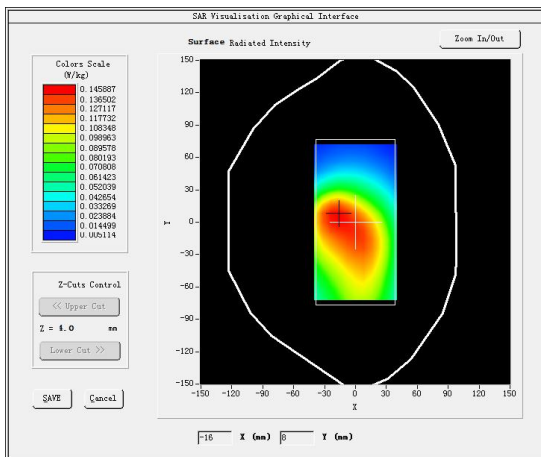

#23

Test Mode: E-UTRA20, Middle channel (Right head cheek)

Product Description: mobile phone

Model: Librem 5

Test Date: April 26, 2021

Medium (liquid type)	HSL_900
Frequency (MHz)	847.0000
Relative permittivity (real part)	42.54
Conductivity (S/m)	0.93
E-Field Probe	SN 31/17 EPGO324
Crest Factor	1.0
Conversion Factor	1.54
Sensor	4mm
Area Scan	dx=8mm dy=8mm
Zoom Scan	5x5x7, dx=8mm dy=8mm dz=5mm
Variation (%)	-0.160000
SAR 10g (W/Kg)	0.103532
SAR 1g (W/Kg)	0.134743

**SURFACE SAR**

**VOLUME SAR**

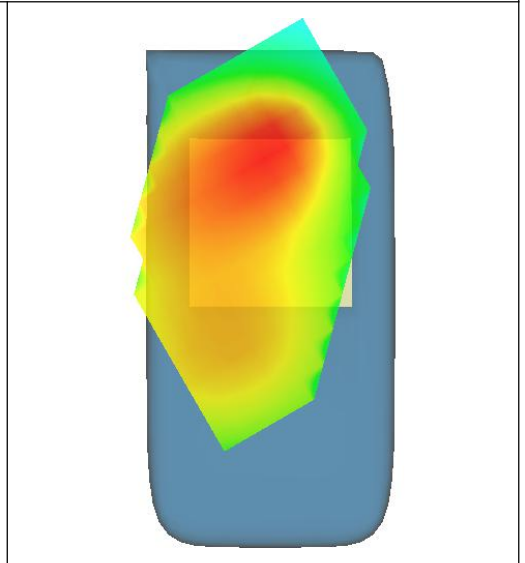
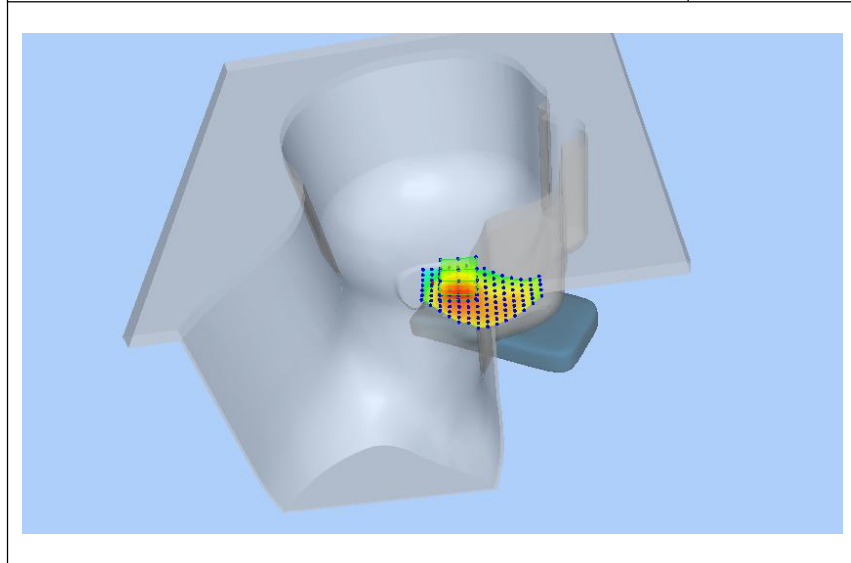
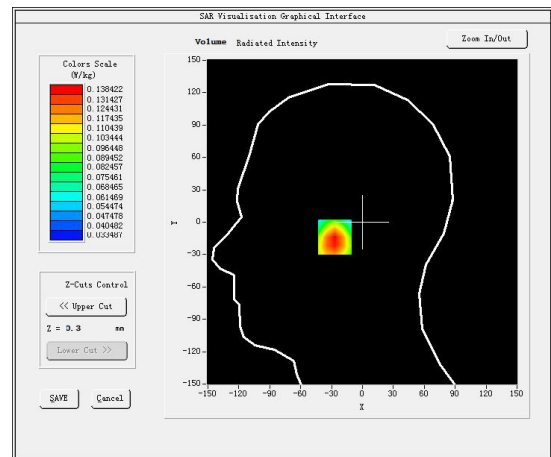
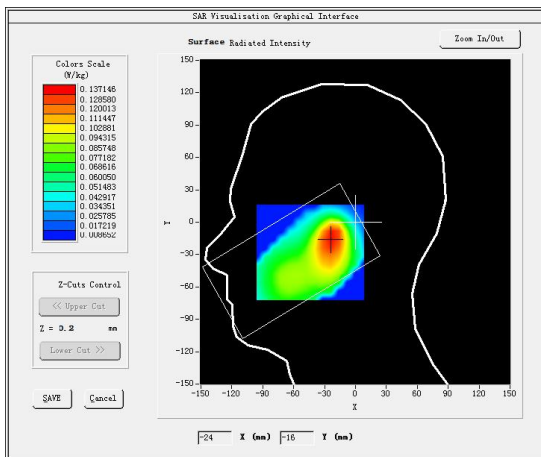

#24

Test Mode: E-UTRA20, Middle channel (Body-LCD Down)

Product Description: mobile phone

Model: Librem 5

Test Date: April 26, 2021

Medium (liquid type)	HSL_900
Frequency (MHz)	847.0000
Relative permittivity (real part)	42.52
Conductivity (S/m)	0.95
E-Field Probe	SN 31/17 EPGO324
Crest Factor	1.0
Conversion Factor	1.54
Sensor	4mm
Area Scan	dx=8mm dy=8mm
Zoom Scan	5x5x7, dx=8mm dy=8mm dz=5mm
Variation (%)	0.040000
SAR 10g (W/Kg)	0.077772
SAR 1g (W/Kg)	0.098661

**SURFACE SAR**

**VOLUME SAR**

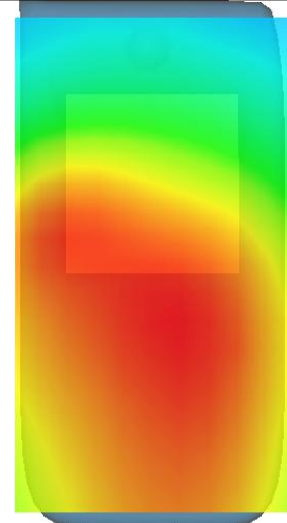
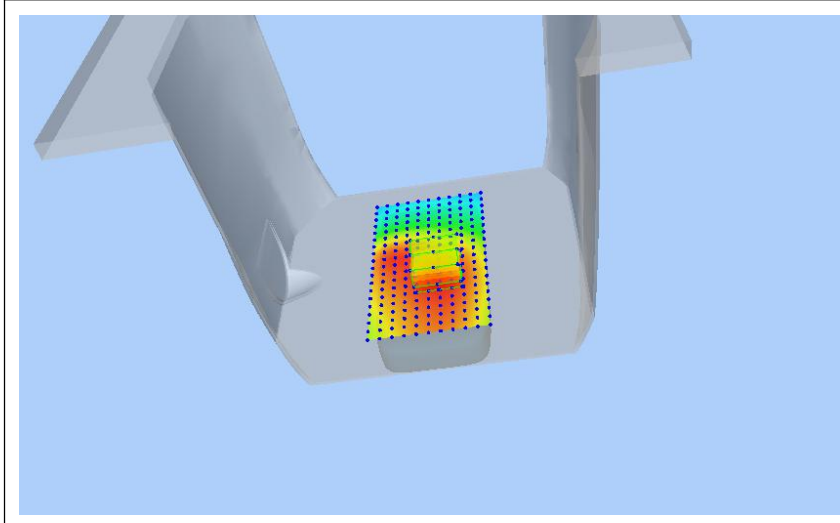
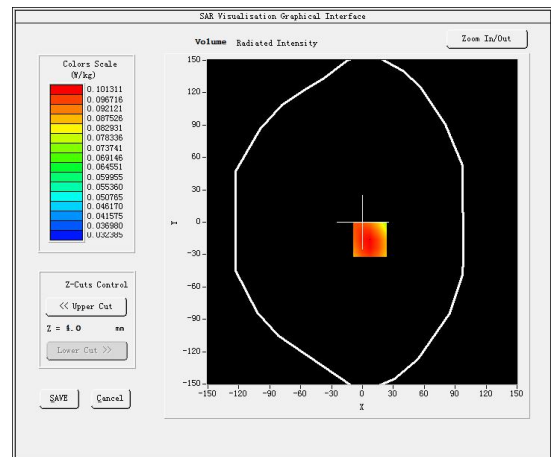
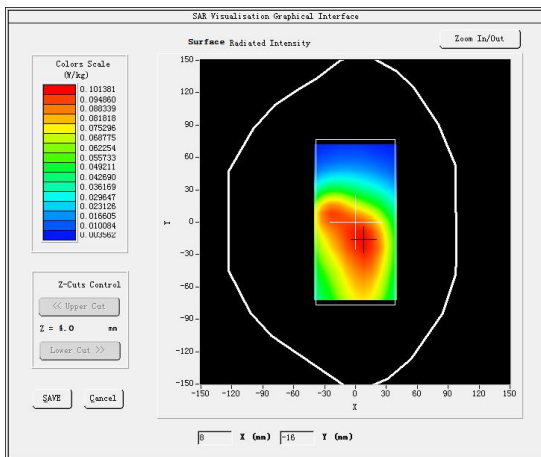

#25

Test Mode: E-UTRA38,Middle channel(Left head cheek)

Product Description: mobile phone

Model:Librem 5

Test Date: May 30, 2021

Medium(liquid type)	HSL_2600
Frequency (MHz)	2595.0000
Relative permittivity (real part)	40.33
Conductivity (S/m)	1.91
E-Field Probe	SN 31/17 EPGO324
Crest Factor	1.0
Conversion Factor	1.89
Sensor	4mm
Area Scan	dx=8mm dy=8mm
Zoom Scan	5x5x7,dx=8mm dy=8mm dz=5mm
Variation (%)	-0.550000
SAR 10g (W/Kg)	0.046509
SAR 1g (W/Kg)	0.068926

**SURFACE SAR**

**VOLUME SAR**

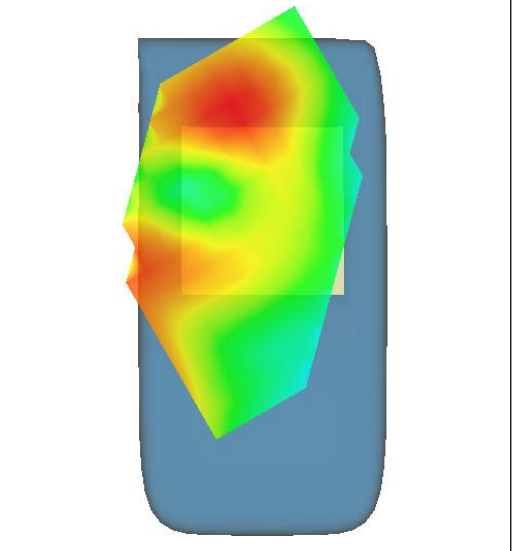
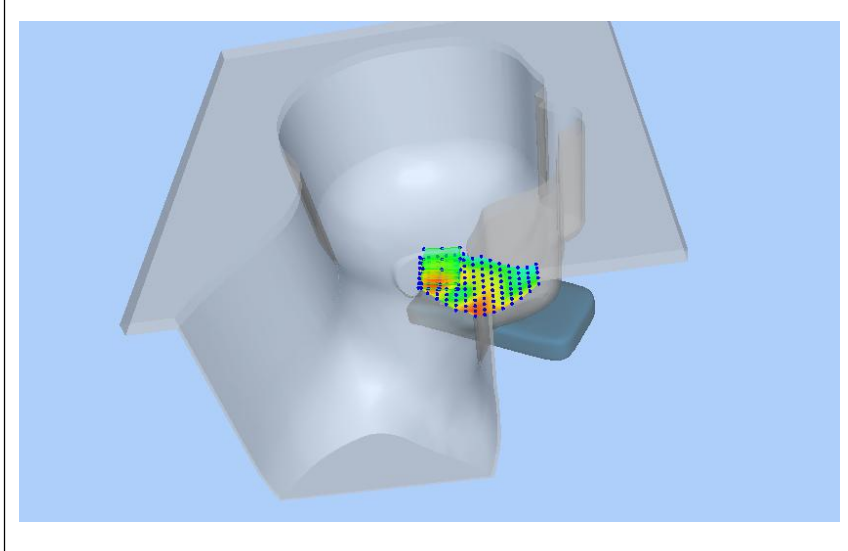
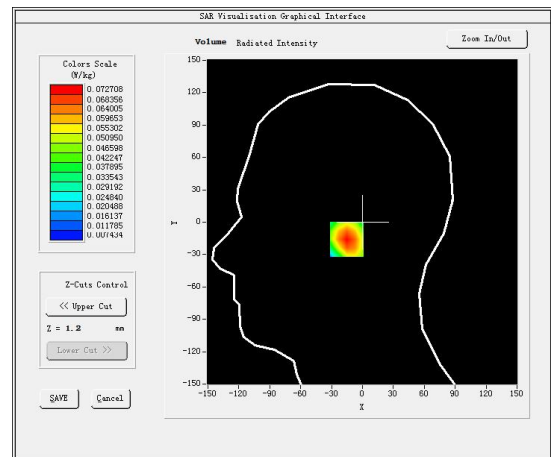
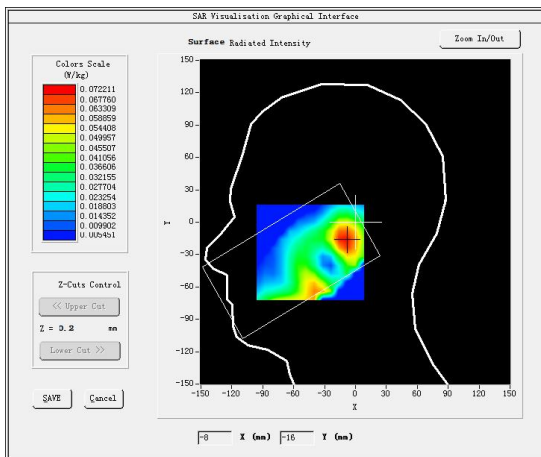



#26

Test Mode: E-UTRA38,Middle channel(Body-LCD Down)

Product Description: mobile phone

Model:Librem 5

Test Date: May 30, 2021

Medium(liquid type)	HSL_2600
Frequency (MHz)	2595.0000
Relative permittivity (real part)	40.38
Conductivity (S/m)	1.92
E-Field Probe	SN 31/17 EPGO324
Crest Factor	1.0
Conversion Factor	1.89
Sensor	4mm
Area Scan	dx=8mm dy=8mm
Zoom Scan	5x5x7,dx=8mm dy=8mm dz=5mm
Variation (%)	1.900000
SAR 10g (W/Kg)	0.357425
SAR 1g (W/Kg)	0.542005

**SURFACE SAR**

**VOLUME SAR**

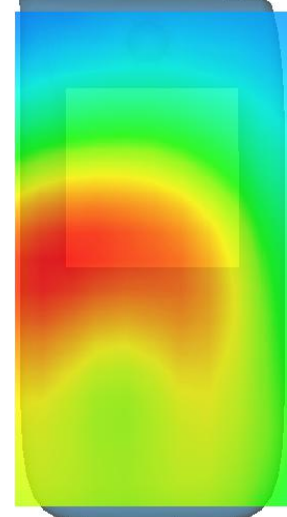
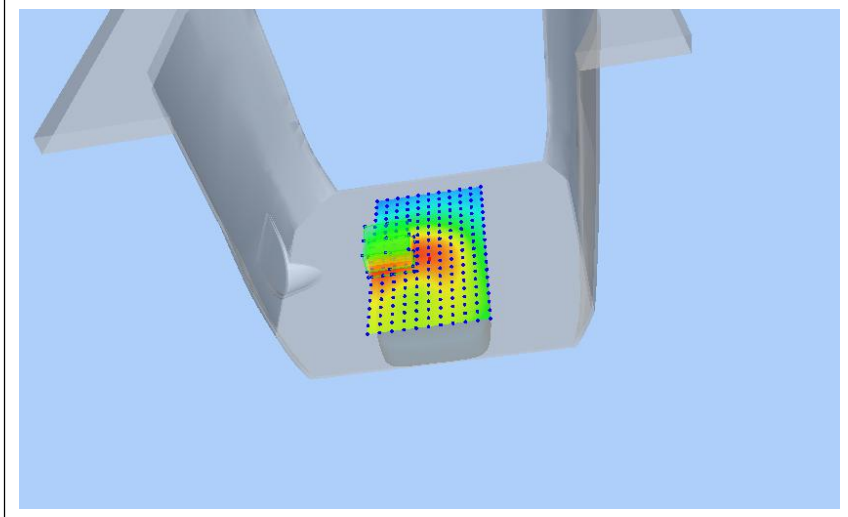
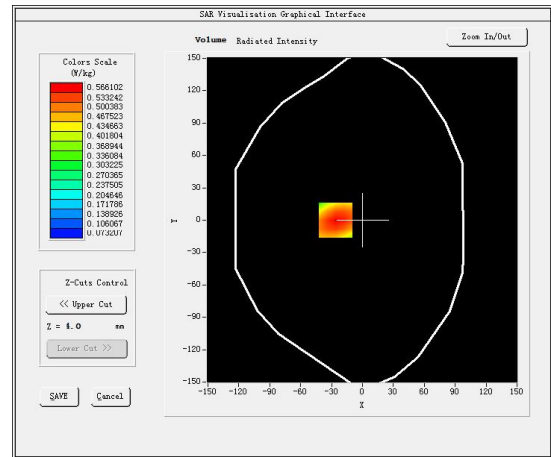
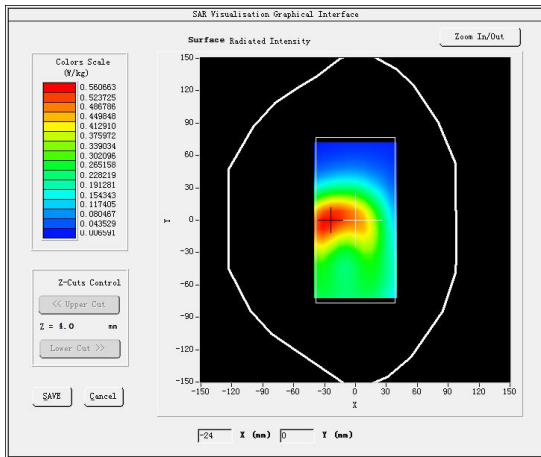

#27

Test Mode: E-UTRA40,Middle channel(Left head cheek)

Product Description: mobile phone

Model:Librem 5

Test Date: May 24, 2021

Medium(liquid type)	HSL_2450
Frequency (MHz)	2350.0000
Relative permittivity (real part)	38.37
Conductivity (S/m)	1.79
E-Field Probe	SN 31/17 EPGO324
Crest Factor	1.0
Conversion Factor	1.91
Sensor	4mm
Area Scan	dx=8mm dy=8mm
Zoom Scan	5x5x7,dx=8mm dy=8mm dz=5mm
Variation (%)	-0.820000
SAR 10g (W/Kg)	0.051186
SAR 1g (W/Kg)	0.076182

**SURFACE SAR**

**VOLUME SAR**

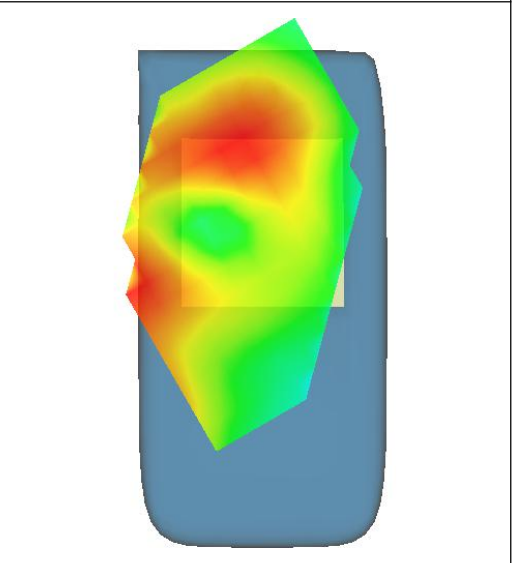
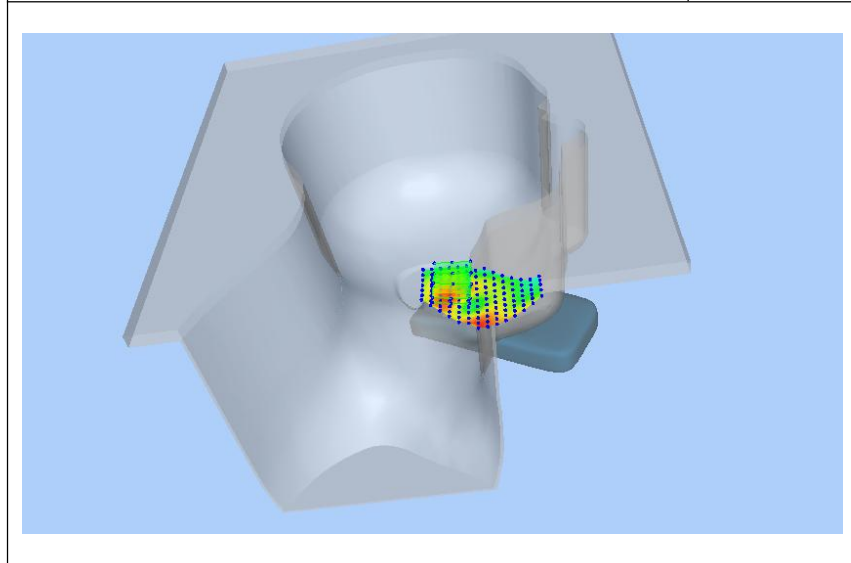
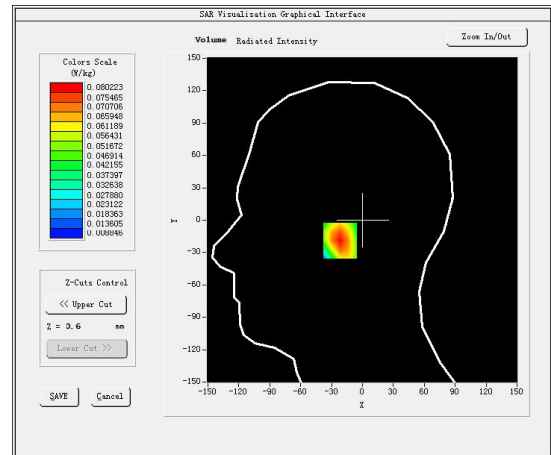
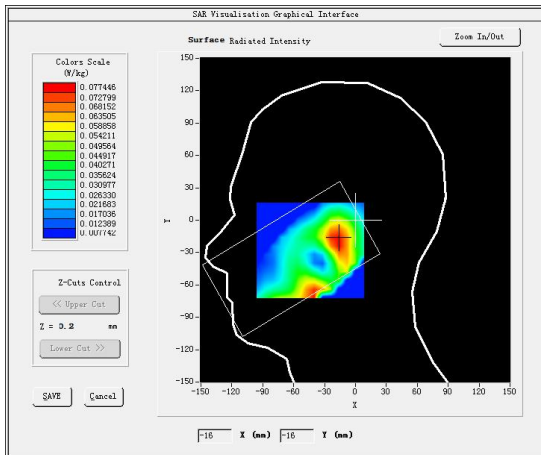

#28

Test Mode: E-UTRA40,Middle channel(Body-LCD Down)

Product Description: mobile phone

Model:Librem 5

Test Date: May 30, 2021

Medium(liquid type)	HSL_2450
Frequency (MHz)	2350.0000
Relative permittivity (real part)	38.41
Conductivity (S/m)	1.81
E-Field Probe	SN 31/17 EPGO324
Crest Factor	1.0
Conversion Factor	1.91
Sensor	4mm
Area Scan	dx=8mm dy=8mm
Zoom Scan	5x5x7,dx=8mm dy=8mm dz=5mm
Variation (%)	1.560000
SAR 10g (W/Kg)	0.693277
SAR 1g (W/Kg)	1.161229

**SURFACE SAR**

**VOLUME SAR**

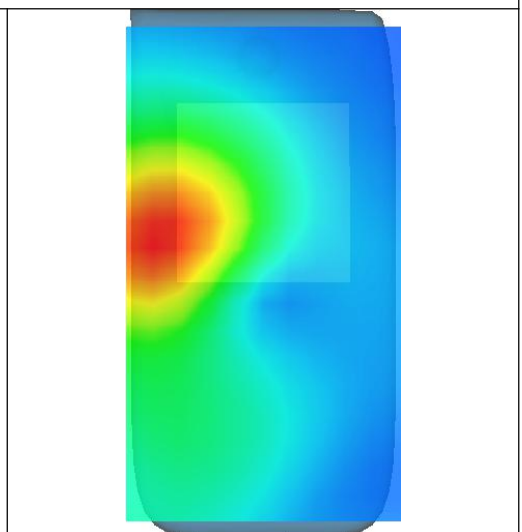
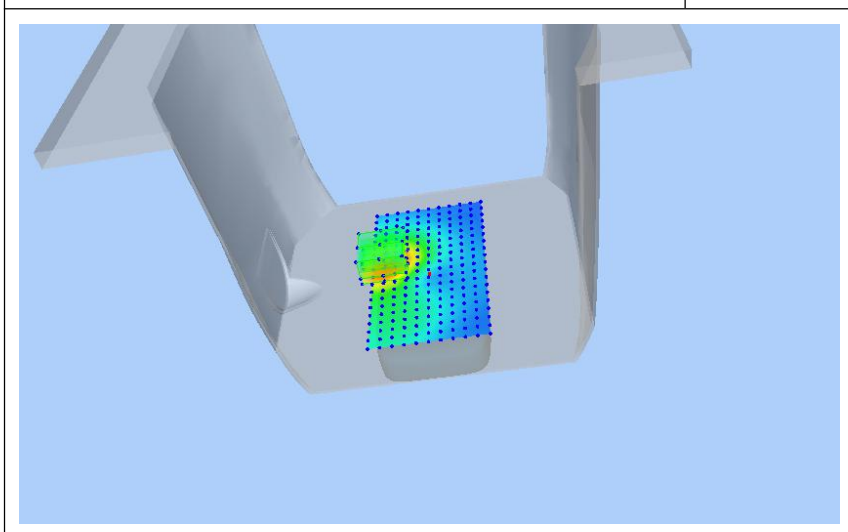
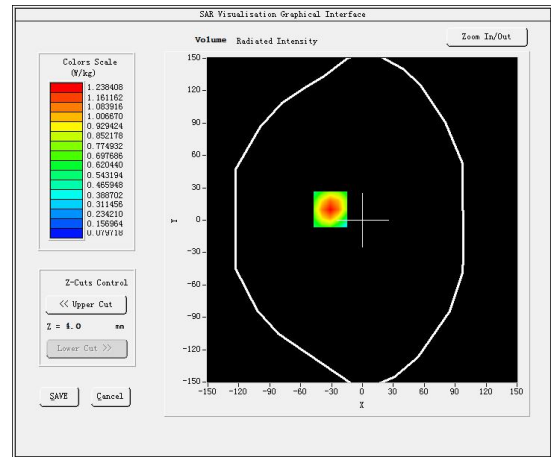
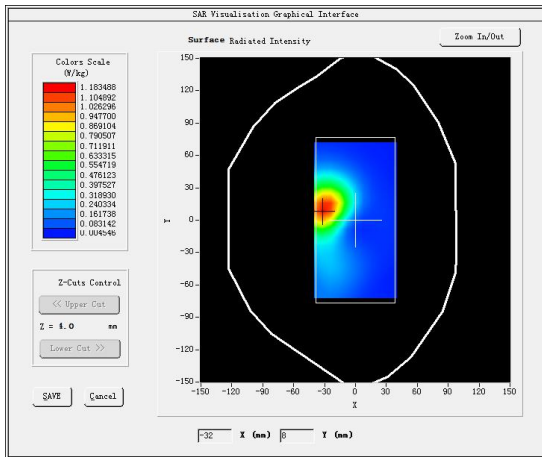

## 5. CALIBRATION CERTIFICATE

### SARTIMO Calibration Certificate-Extended Dipole Calibrations

According to KDB 450824 D02, Dipoles must be recalibrated at least once every three years; however, immediate re-calibration is required for following conditions. The test laboratory must ensure that the required supporting information and documentation have been included in the SAR report to qualify for extended 3-year calibration interval.

- 1) When the most recent return-loss, measured at least annually, deviates by more than 20% from the previous measurement (i.e. 0.2 of the dB value) or not meeting the required -20 dB return-loss specification
- 2) When the most recent measurement of the real or imaginary parts of the impedance, measured at least annually, deviates by more than  $5\Omega$  from the previous measurement

Summary Result:

#### SID900 SN 07/14 DIP 0G900-300 Extend Dipole Calibrations

Date of Measurement	Return-Loss (dB)	Delta (%)	Real Impedance (ohm)	Delta (ohm)	Imaginary Impedance (ohm)	Delta (ohm)
2018-10-01	-23.55		52.8		5.4	
2019-10-01	-23.49	-0.26	52.5	-0.3	5.3	-0.1
2020-10-01	-23.51	-0.17	52.6	-0.2	5.2	-0.2

#### SID1800 SN 30/14 DIP 1G800-301 Extend Dipole Calibrations

Date of Measurement	Return-Loss (dB)	Delta (%)	Real Impedance (ohm)	Delta (ohm)	Imaginary Impedance (ohm)	Delta (ohm)
2018-10-01	-20.26		43.1		6.9	
2019-10-01	-20.13	-0.64	42.9	-0.2	6.7	-0.2
2020-10-01	-20.20	-0.30	43.0	-0.1	6.6	-0.3

#### SID2000 SN 07/14 DIP 2G000-305 Extend Dipole Calibrations

Date of Measurement	Return-Loss (dB)	Delta (%)	Real Impedance (ohm)	Delta (ohm)	Imaginary Impedance (ohm)	Delta (ohm)
2018-10-01	-23.67		50.8		6.2	
2019-10-01	-23.46	-0.89	51.0	0.2	6.5	0.3
2020-10-01	-23.50	-0.72	51.2	0.4	6.3	0.1

#### SID2450 SN 07/14 DIP 2G450-306 Extend Dipole Calibrations

Date of Measurement	Return-Loss (dB)	Delta (%)	Real Impedance (ohm)	Delta (ohm)	Imaginary Impedance (ohm)	Delta (ohm)
2018-10-01	-25.59		44.7		-1.1	
2019-10-01	-25.68	0.35	44.8	0.1	-1.0	0.1
2020-10-01	-25.66	0.27	44.9	0.2	-0.9	0.2

#### SID2600 SN 38/18 DIP 2G600-468 Extend Dipole Calibrations

Date of Measurement	Return-Loss (dB)	Delta (%)	Real Impedance (ohm)	Delta (ohm)	Imaginary Impedance (ohm)	Delta (ohm)
2018-09-24	-29.14		49.2		3.4	
2019-09-24	-29.12	-0.07	49.1	-0.1	3.2	-0.2
2020-10-01	-29.13	-0.03	49.0	-0.2	3.0	-0.4

#### SID5200 SN 49/16 DIP WGA43 Extend Dipole Calibrations

Date of Measurement	Return-Loss (dB)	Delta (%)	Real Impedance (ohm)	Delta (ohm)	Imaginary Impedance (ohm)	Delta (ohm)
2018-09-24	-8.59		19.38		13.50	
2019-09-24	-8.62	0.35	19.25	-0.13	13.47	-0.03
2020-09-24	-8.63	0.47	19.26	-0.12	13.45	-0.05

## SID5800 SN 49/16 DIP WGA43 Extend Dipole Calibrations

Date of Measurement	Return-Loss (dB)	Delta (%)	Real Impedance (ohm)	Delta (ohm)	Imaginary Impedance (ohm)	Delta (ohm)
2018-09-24	-11.37		54.79		25.47	
2019-09-24	-11.42	0.44	54.68	-0.11	25.26	-0.21
2020-09-24	-11.44	0.62	54.80	0.10	25.28	-0.19

## 5.1 Probe-EPGO324 Calibration Certificate



### COMOSAR E-Field Probe Calibration Report

Ref : ACR.281.2.18.SATU.A

#### SHENZHEN LCS COMPLIANCE TESTING LABORATORY LTD.

1F., XINGYUAN INDUSTRIAL PARK, TONGDA ROAD,  
BAO'AN BLVD  
BAO'AN DISTRICT, SHENZHEN, GUANGDONG, CHINA  
MVG COMOSAR DOSIMETRIC E-FIELD PROBE  
SERIAL NO.: SN 31/17 EPGO324

Calibrated at MVG US

2105 Barrett Park Dr. - Kennesaw, GA 30144



Calibration Date: 10/07/2020

#### Summary:

This document presents the method and results from an accredited COMOSAR Dosimetric E-Field Probe calibration performed in MVG USA using the CALISAR / CALIBAIR test bench, for use with a COMOSAR system only. All calibration results are traceable to national metrology institutions.



COMOSAR E-FIELD PROBE CALIBRATION REPORT

Ref: ACR.281.2.18.SATU.A

	Name	Function	Date	Signature
Prepared by :	Jérôme LUC	Product Manager	10/7/2020	<i>JS</i>
Checked by :	Jérôme LUC	Product Manager	10/7/2020	<i>JS</i>
Approved by :	Kim RUTKOWSKI	Quality Manager	10/7/2020	<i>Kim Rutkowski</i>

	Customer Name
Distribution :	Shenzhen LCS Compliance Testing Laboratory Ltd.

Issue	Date	Modifications
A	10/7/2020	Initial release

*This document shall not be reproduced, except in full or in part, without the written approval of MVG. The information contained herein is to be used only for the purpose for which it is submitted and is not to be released in whole or part without written approval of MVG.*



## COMOSAR E-FIELD PROBE CALIBRATION REPORT

Ref: ACR.281.2.18.SATU.A

## TABLE OF CONTENTS

1	Device Under Test .....	4
2	Product Description .....	4
2.1	General Information .....	4
3	Measurement Method .....	4
3.1	Linearity .....	4
3.2	Sensitivity .....	5
3.3	Lower Detection Limit .....	5
3.4	Isotropy .....	5
3.5	Boundary Effect .....	5
4	Measurement Uncertainty.....	5
5	Calibration Measurement Results.....	6
5.1	Sensitivity in air .....	6
5.2	Linearity .....	7
5.3	Sensitivity in liquid .....	7
5.4	Isotropy .....	8
6	List of Equipment .....	10

Page: 3/10

*This document shall not be reproduced, except in full or in part, without the written approval of MVG.  
The information contained herein is to be used only for the purpose for which it is submitted and is not to be released in whole or part without written approval of MVG.*





## COMOSAR E-FIELD PROBE CALIBRATION REPORT

Ref: ACR.281.2.18.SATU.A

## 1 DEVICE UNDER TEST

Device Under Test	
Device Type	COMOSAR DOSIMETRIC E FIELD PROBE
Manufacturer	MVG
Model	SSE2
Serial Number	SN 31/17 EPGO324
Product Condition (new / used)	New
Frequency Range of Probe	0.15 GHz-6GHz
Resistance of Three Dipoles at Connector	Dipole 1: R1=0.189 MΩ Dipole 2: R2=0.203 MΩ Dipole 3: R3=0.218 MΩ

A yearly calibration interval is recommended.

## 2 PRODUCT DESCRIPTION

### 2.1 GENERAL INFORMATION

MVG's COMOSAR E field Probes are built in accordance to the IEEE 1528, OET 65 Bulletin C and CEI/IEC 62209 standards.



**Figure 1** – MVG COMOSAR Dosimetric E field Dipole

Probe Length	330 mm
Length of Individual Dipoles	2 mm
Maximum external diameter	8 mm
Probe Tip External Diameter	2.5 mm
Distance between dipoles / probe extremity	1 mm

## 3 MEASUREMENT METHOD

The IEEE 1528, OET 65 Bulletin C, CENELEC EN50361 and CEI/IEC 62209 standards provide recommended practices for the probe calibrations, including the performance characteristics of interest and methods by which to assess their affect. All calibrations / measurements performed meet the fore mentioned standards.

### 3.1 LINEARITY

The evaluation of the linearity was done in free space using the waveguide, performing a power sweep to cover the SAR range 0.01W/kg to 100W/kg.

Page: 4/10

*This document shall not be reproduced, except in full or in part, without the written approval of MVG.  
The information contained herein is to be used only for the purpose for which it is submitted and is not to be released in whole or part without written approval of MVG.*



## COMOSAR E-FIELD PROBE CALIBRATION REPORT

Ref: ACR.281.2.18.SATU.A

### 3.2 SENSITIVITY

The sensitivity factors of the three dipoles were determined using a two step calibration method (air and tissue simulating liquid) using waveguides as outlined in the standards.

### 3.3 LOWER DETECTION LIMIT

The lower detection limit was assessed using the same measurement set up as used for the linearity measurement. The required lower detection limit is 10 mW/kg.

### 3.4 ISOTROPY

The axial isotropy was evaluated by exposing the probe to a reference wave from a standard dipole with the dipole mounted under the flat phantom in the test configuration suggested for system validations and checks. The probe was rotated along its main axis from 0 - 360 degrees in 15 degree steps. The hemispherical isotropy is determined by inserting the probe in a thin plastic box filled with tissue-equivalent liquid, with the plastic box illuminated with the fields from a half wave dipole. The dipole is rotated about its axis (0°–180°) in 15° increments. At each step the probe is rotated about its axis (0°–360°).

### 3.5 BOUNDARY EFFECT

The boundary effect is defined as the deviation between the SAR measured data and the expected exponential decay in the liquid when the probe is oriented normal to the interface. To evaluate this effect, the liquid filled flat phantom is exposed to fields from either a reference dipole or waveguide. With the probe normal to the phantom surface, the peak spatial average SAR is measured and compared to the analytical value at the surface.

## 4 MEASUREMENT UNCERTAINTY

The guidelines outlined in the IEEE 1528, OET 65 Bulletin C, CENELEC EN50361 and CEI/IEC 62209 standards were followed to generate the measurement uncertainty associated with an E-field probe calibration using the waveguide technique. All uncertainties listed below represent an expanded uncertainty expressed at approximately the 95% confidence level using a coverage factor of k=2, traceable to the Internationally Accepted Guides to Measurement Uncertainty.

Uncertainty analysis of the probe calibration in waveguide					
ERROR SOURCES	Uncertainty value (%)	Probability Distribution	Divisor	ci	Standard Uncertainty (%)
Incident or forward power	3.00%	Rectangular	$\sqrt{3}$	1	1.732%
Reflected power	3.00%	Rectangular	$\sqrt{3}$	1	1.732%
Liquid conductivity	5.00%	Rectangular	$\sqrt{3}$	1	2.887%
Liquid permittivity	4.00%	Rectangular	$\sqrt{3}$	1	2.309%
Field homogeneity	3.00%	Rectangular	$\sqrt{3}$	1	1.732%
Field probe positioning	5.00%	Rectangular	$\sqrt{3}$	1	2.887%

Page: 5/10

*This document shall not be reproduced, except in full or in part, without the written approval of MVG.  
The information contained herein is to be used only for the purpose for which it is submitted and is not to be released in whole or part without written approval of MVG.*



## COMOSAR E-FIELD PROBE CALIBRATION REPORT

Ref: ACR.281.2.18.SATU.A

Field probe linearity	3.00%	Rectangular	$\sqrt{3}$	1	1.732%
<b>Combined standard uncertainty</b>					5.831%
<b>Expanded uncertainty</b> 95 % confidence level k = 2					12.0%

## 5 CALIBRATION MEASUREMENT RESULTS

Calibration Parameters	
Liquid Temperature	21 °C
Lab Temperature	21 °C
Lab Humidity	45 %

## 5.1 SENSITIVITY IN AIR

Normx dipole 1 ( $\mu\text{V}/(\text{V}/\text{m})^2$ )	Normy dipole 2 ( $\mu\text{V}/(\text{V}/\text{m})^2$ )	Normz dipole 3 ( $\mu\text{V}/(\text{V}/\text{m})^2$ )
0.80	0.83	0.68

DCP dipole 1 (mV)	DCP dipole 2 (mV)	DCP dipole 3 (mV)
95	90	93

Calibration curves  $e_i=f(V)$  ( $i=1,2,3$ ) allow to obtain H-field value using the formula:

$$E = \sqrt{E_1^2 + E_2^2 + E_3^2}$$

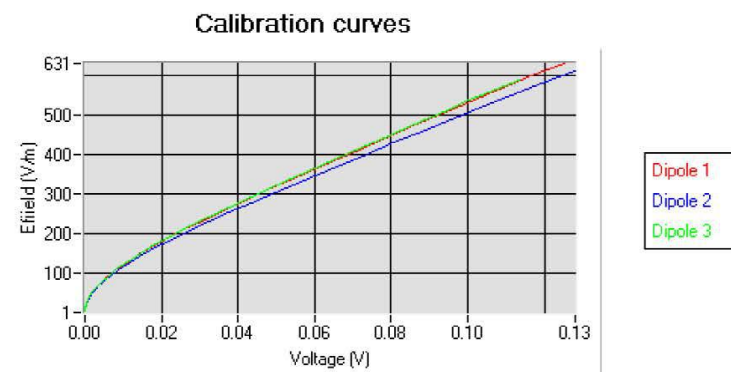

Page: 6/10

*This document shall not be reproduced, except in full or in part, without the written approval of MVG.  
The information contained herein is to be used only for the purpose for which it is submitted and is not to be released in whole or part without written approval of MVG.*



## COMOSAR E-FIELD PROBE CALIBRATION REPORT

Ref: ACR.281.2.18.SATU.A

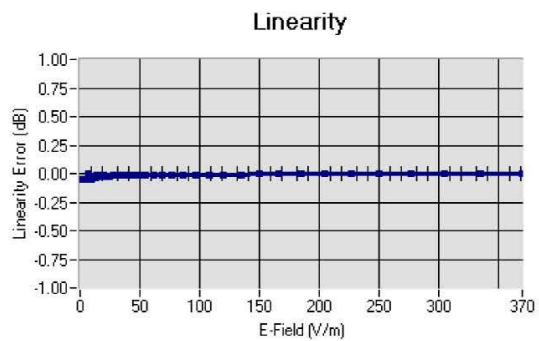
5.2 LINEARITYLinearity:  $\pm 1.13\%$  ( $\pm 0.05\text{dB}$ )5.3 SENSITIVITY IN LIQUID

Liquid	Frequency (MHz +/- 100MHz)	Permittivity	Epsilon (S/m)	ConvF
HL450	450	42.17	0.86	1.56
BL450	450	57.65	0.95	1.60
HL750	750	40.03	0.93	1.45
BL750	750	56.83	1.00	1.50
HL850	835	42.19	0.90	1.55
BL850	835	54.67	1.01	1.59
HL900	900	42.08	1.01	1.54
BL900	900	55.25	1.08	1.60
HL1800	1800	41.68	1.46	1.65
BL1800	1800	53.86	1.46	1.68
HL1900	1900	38.45	1.45	1.86
BL1900	1900	53.32	1.56	1.93
HL2000	2000	38.26	1.38	1.83
BL2000	2000	52.70	1.51	1.89
HL2300	2300	39.44	1.62	1.95
BL2300	2300	54.52	1.77	2.01
HL2450	2450	37.50	1.80	1.91
BL2450	2450	53.22	1.89	1.95
HL2600	2600	39.80	1.99	1.89
BL2600	2600	52.52	2.23	1.94
HL5200	5200	35.64	4.67	1.50
BL5200	5200	48.64	5.51	1.56
HL5400	5400	36.44	4.87	1.44
BL5400	5400	46.52	5.77	1.47
HL5600	5600	36.66	5.17	1.48
BL5600	5600	46.79	5.77	1.53
HL5800	5800	35.31	5.31	1.50
BL5800	5800	47.04	6.10	1.55

LOWER DETECTION LIMIT: 9mW/kg

Page: 7/10

*This document shall not be reproduced, except in full or in part, without the written approval of MVG.  
The information contained herein is to be used only for the purpose for which it is submitted and is not to be released in whole or part without written approval of MVG.*



COMOSAR E-FIELD PROBE CALIBRATION REPORT

Ref: ACR.281.2.18.SATU.A

5.4 ISOTROPY

**HL900 MHz**

- Axial isotropy: 0.05 dB
- Hemispherical isotropy: 0.07 dB

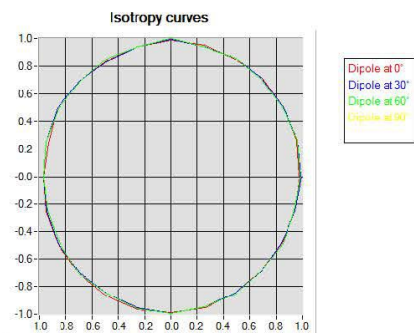

**HL1800 MHz**

- Axial isotropy: 0.06 dB
- Hemispherical isotropy: 0.07 dB

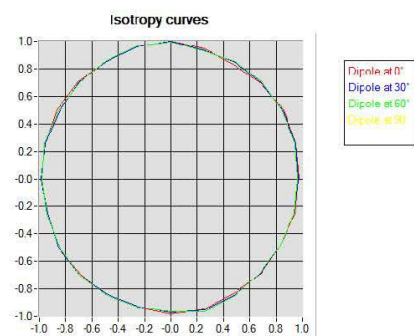

*This document shall not be reproduced, except in full or in part, without the written approval of MVG. The information contained herein is to be used only for the purpose for which it is submitted and is not to be released in whole or part without written approval of MVG.*



COMOSAR E-FIELD PROBE CALIBRATION REPORT

Ref: ACR.281.2.18.SATU.A

**HL5600 MHz**

- Axial isotropy: 0.06 dB
- Hemispherical isotropy: 0.10 dB

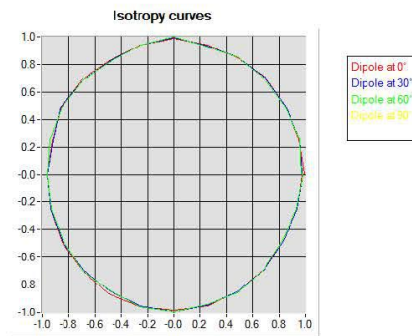

*This document shall not be reproduced, except in full or in part, without the written approval of MVG.  
The information contained herein is to be used only for the purpose for which it is submitted and is not to be released in whole or part without written approval of MVG.*



## COMOSAR E-FIELD PROBE CALIBRATION REPORT

Ref: ACR.281.2.18.SATU.A

## 6 LIST OF EQUIPMENT

Equipment Summary Sheet				
Equipment Description	Manufacturer / Model	Identification No.	Current Calibration Date	Next Calibration Date
Flat Phantom	MVG	SN-20/09-SAM71	Validated. No cal required.	Validated. No cal required.
COMOSAR Test Bench	Version 3	NA	Validated. No cal required.	Validated. No cal required.
Network Analyzer	Rhode & Schwarz ZVA	SN100132	02/2019	02/2022
Reference Probe	MVG	EP 94 SN 37/08	10/2019	10/2021
Multimeter	Keithley 2000	1188656	01/2020	01/2023
Signal Generator	Agilent E4438C	MY49070581	01/2020	01/2023
Amplifier	Aethercomm	SN 046	Characterized prior to test. No cal required.	Characterized prior to test. No cal required.
Power Meter	HP E4418A	US38261498	01/2020	01/2023
Power Sensor	HP ECP-E26A	US37181460	01/2020	01/2023
Directional Coupler	Narda 4216-20	01386	Characterized prior to test. No cal required.	Characterized prior to test. No cal required.
Waveguide	Mega Industries	069Y7-158-13-712	Validated. No cal required.	Validated. No cal required.
Waveguide Transition	Mega Industries	069Y7-158-13-701	Validated. No cal required.	Validated. No cal required.
Waveguide Termination	Mega Industries	069Y7-158-13-701	Validated. No cal required.	Validated. No cal required.
Temperature / Humidity Sensor	Control Company	150798832	11/2020	11/2023

Page: 10/10

*This document shall not be reproduced, except in full or in part, without the written approval of MVG.  
The information contained herein is to be used only for the purpose for which it is submitted and is not to be released in whole or part without written approval of MVG.*

## 5.2 SID900 Dipole Calibration Certificate



### SAR Reference Dipole Calibration Report

Ref : ACR.287.5.14.SATU.A

**SHENZHEN LCS COMPLIANCE TESTING  
LABORATORY LTD.**

**1F., XINGYUAN INDUSTRIAL PARK, TONGDA ROAD,  
BAO'AN BLVD**

**BAO'AN DISTRICT, SHENZHEN, GUANGDONG, CHINA**

**SATIMO COMOSAR REFERENCE DIPOLE**

**FREQUENCY: 900 MHZ**

**SERIAL NO.: SN 07/14 DIP 0G900-300**

**Calibrated at SATIMO US**

**2105 Barrett Park Dr. - Kennesaw, GA 30144**



**10/01/2018**

*Summary:*

This document presents the method and results from an accredited SAR reference dipole calibration performed in SATIMO USA using the COMOSAR test bench. All calibration results are traceable to national metrology institutions.





## SAR REFERENCE DIPOLE CALIBRATION REPORT

Ref: ACR.287.5.14.SATU.A

	<i>Name</i>	<i>Function</i>	<i>Date</i>	<i>Signature</i>
<i>Prepared by :</i>	Jérôme LUC	Product Manager	10/14/2018	<i>JS</i>
<i>Checked by :</i>	Jérôme LUC	Product Manager	10/14/2018	<i>JS</i>
<i>Approved by :</i>	Kim RUTKOWSKI	Quality Manager	10/14/2018	<i>Kim Rutkowski</i>

	<i>Customer Name</i>
<i>Distribution :</i>	Shenzhen LCS Compliance Testing Laboratory Ltd.

<i>Issue</i>	<i>Date</i>	<i>Modifications</i>
A	10/14/2018	Initial release

Page: 2/11

*This document shall not be reproduced, except in full or in part, without the written approval of SATIMO.  
The information contained herein is to be used only for the purpose for which it is submitted and is not to  
be released in whole or part without written approval of SATIMO.*



## TABLE OF CONTENTS

1	Introduction.....	4
2	Device Under Test .....	4
3	Product Description .....	4
3.1	General Information .....	4
4	Measurement Method .....	5
4.1	Return Loss Requirements .....	5
4.2	Mechanical Requirements .....	5
5	Measurement Uncertainty .....	5
5.1	Return Loss .....	5
5.2	Dimension Measurement .....	5
5.3	Validation Measurement .....	5
6	Calibration Measurement Results .....	6
6.1	Return Loss and Impedance .....	6
6.2	Mechanical Dimensions .....	6
7	Validation measurement .....	7
7.1	Head Liquid Measurement .....	7
7.2	SAR Measurement Result With Head Liquid .....	7
7.3	Body Liquid Measurement .....	9
7.4	SAR Measurement Result With Body Liquid .....	9
8	List of Equipment .....	11

Page: 3/11

*This document shall not be reproduced, except in full or in part, without the written approval of SATIMO.  
The information contained herein is to be used only for the purpose for which it is submitted and is not to be released in whole or part without written approval of SATIMO.*



## 1 INTRODUCTION

This document contains a summary of the requirements set forth by the IEEE 1528, OET 65 Bulletin C and CEI/IEC 62209 standards for reference dipoles used for SAR measurement system validations and the measurements that were performed to verify that the product complies with the fore mentioned standards.

## 2 DEVICE UNDER TEST

Device Under Test	
Device Type	COMOSAR 900 MHz REFERENCE DIPOLE
Manufacturer	Satimo
Model	SID900
Serial Number	SN 07/14 DIP 0G900-300
Product Condition (new / used)	New

A yearly calibration interval is recommended.

## 3 PRODUCT DESCRIPTION

### 3.1 GENERAL INFORMATION

Satimo's COMOSAR Validation Dipoles are built in accordance to the IEEE 1528, OET 65 Bulletin C and CEI/IEC 62209 standards. The product is designed for use with the COMOSAR test bench only.



**Figure 1** – Satimo COMOSAR Validation Dipole



#### 4 MEASUREMENT METHOD

The IEEE 1528, OET 65 Bulletin C and CEI/IEC 62209 standards provide requirements for reference dipoles used for system validation measurements. The following measurements were performed to verify that the product complies with the fore mentioned standards.

##### 4.1 RETURN LOSS REQUIREMENTS

The dipole used for SAR system validation measurements and checks must have a return loss of -20 dB or better. The return loss measurement shall be performed against a liquid filled flat phantom, with the phantom constructed as outlined in the fore mentioned standards.

##### 4.2 MECHANICAL REQUIREMENTS

The IEEE Std. 1528 and CEI/IEC 62209 standards specify the mechanical components and dimensions of the validation dipoles, with the dimensions frequency and phantom shell thickness dependent. The COMOSAR test bench employs a 2 mm phantom shell thickness therefore the dipoles sold for use with the COMOSAR test bench comply with the requirements set forth for a 2 mm phantom shell thickness.

#### 5 MEASUREMENT UNCERTAINTY

All uncertainties listed below represent an expanded uncertainty expressed at approximately the 95% confidence level using a coverage factor of  $k=2$ , traceable to the Internationally Accepted Guides to Measurement Uncertainty.

##### 5.1 RETURN LOSS

The following uncertainties apply to the return loss measurement:

Frequency band	Expanded Uncertainty on Return Loss
400-6000MHz	0.1 dB

##### 5.2 DIMENSION MEASUREMENT

The following uncertainties apply to the dimension measurements:

Length (mm)	Expanded Uncertainty on Length
3 - 300	0.05 mm

##### 5.3 VALIDATION MEASUREMENT

The guidelines outlined in the IEEE 1528, OET 65 Bulletin C, CENELEC EN50361 and CEI/IEC 62209 standards were followed to generate the measurement uncertainty for validation measurements.

Scan Volume	Expanded Uncertainty
1 g	20.3 %
10 g	20.1 %

Page: 5/11

*This document shall not be reproduced, except in full or in part, without the written approval of SATIMO. The information contained herein is to be used only for the purpose for which it is submitted and is not to be released in whole or part without written approval of SATIMO.*



6 CALIBRATION MEASUREMENT RESULTS

6.1 RETURN LOSS AND IMPEDANCE

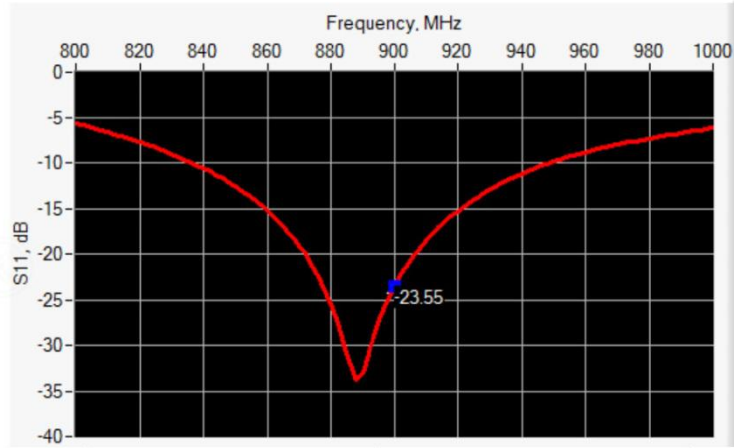

Frequency (MHz)	Return Loss (dB)	Requirement (dB)	Impedance
900	-23.55	-20	52.8 Ω - 5.4 jΩ

6.2 MECHANICAL DIMENSIONS

Frequency MHz	L mm		h mm		d mm	
	required	measured	required	measured	required	measured
300	420.0 ±1 %.		250.0 ±1 %.		6.35 ±1 %.	
450	290.0 ±1 %.		166.7 ±1 %.		6.35 ±1 %.	
750	176.0 ±1 %.		100.0 ±1 %.		6.35 ±1 %.	
835	161.0 ±1 %.		89.8 ±1 %.		3.6 ±1 %.	
900	149.0 ±1 %.	PASS	83.3 ±1 %.	PASS	3.6 ±1 %.	PASS
1450	89.1 ±1 %.		51.7 ±1 %.		3.6 ±1 %.	
1500	80.5 ±1 %.		50.0 ±1 %.		3.6 ±1 %.	
1640	79.0 ±1 %.		45.7 ±1 %.		3.6 ±1 %.	
1750	75.2 ±1 %.		42.9 ±1 %.		3.6 ±1 %.	
1800	72.0 ±1 %.		41.7 ±1 %.		3.6 ±1 %.	
1900	68.0 ±1 %.		39.5 ±1 %.		3.6 ±1 %.	
1950	66.3 ±1 %.		38.5 ±1 %.		3.6 ±1 %.	
2000	64.5 ±1 %.		37.5 ±1 %.		3.6 ±1 %.	
2100	61.0 ±1 %.		35.7 ±1 %.		3.6 ±1 %.	
2300	55.5 ±1 %.		32.6 ±1 %.		3.6 ±1 %.	
2450	51.5 ±1 %.		30.4 ±1 %.		3.6 ±1 %.	
2600	48.5 ±1 %.		28.8 ±1 %.		3.6 ±1 %.	
3000	41.5 ±1 %.		25.0 ±1 %.		3.6 ±1 %.	
3500	37.0 ±1 %.		26.4 ±1 %.		3.6 ±1 %.	
3700	34.7 ±1 %.		26.4 ±1 %.		3.6 ±1 %.	

*This document shall not be reproduced, except in full or in part, without the written approval of SATIMO. The information contained herein is to be used only for the purpose for which it is submitted and is not to be released in whole or part without written approval of SATIMO.*



## 7 VALIDATION MEASUREMENT

The IEEE Std. 1528, OET 65 Bulletin C and CEI/IEC 62209 standards state that the system validation measurements must be performed using a reference dipole meeting the fore mentioned return loss and mechanical dimension requirements. The validation measurement must be performed against a liquid filled flat phantom, with the phantom constructed as outlined in the fore mentioned standards. Per the standards, the dipole shall be positioned below the bottom of the phantom, with the dipole length centered and parallel to the longest dimension of the flat phantom, with the top surface of the dipole at the described distance from the bottom surface of the phantom.

### 7.1 HEAD LIQUID MEASUREMENT

Frequency MHz	Relative permittivity ( $\epsilon_r'$ )		Conductivity ( $\sigma$ ) S/m	
	required	measured	required	measured
300	45.3 $\pm$ 5 %		0.87 $\pm$ 5 %	
450	43.5 $\pm$ 5 %		0.87 $\pm$ 5 %	
750	41.9 $\pm$ 5 %		0.89 $\pm$ 5 %	
835	41.5 $\pm$ 5 %		0.90 $\pm$ 5 %	
900	41.5 $\pm$ 5 %	PASS	0.97 $\pm$ 5 %	PASS
1450	40.5 $\pm$ 5 %		1.20 $\pm$ 5 %	
1500	40.4 $\pm$ 5 %		1.23 $\pm$ 5 %	
1640	40.2 $\pm$ 5 %		1.31 $\pm$ 5 %	
1750	40.1 $\pm$ 5 %		1.37 $\pm$ 5 %	
1800	40.0 $\pm$ 5 %		1.40 $\pm$ 5 %	
1900	40.0 $\pm$ 5 %		1.40 $\pm$ 5 %	
1950	40.0 $\pm$ 5 %		1.40 $\pm$ 5 %	
2000	40.0 $\pm$ 5 %		1.40 $\pm$ 5 %	
2100	39.8 $\pm$ 5 %		1.49 $\pm$ 5 %	
2300	39.5 $\pm$ 5 %		1.67 $\pm$ 5 %	
2450	39.2 $\pm$ 5 %		1.80 $\pm$ 5 %	
2600	39.0 $\pm$ 5 %		1.96 $\pm$ 5 %	
3000	38.5 $\pm$ 5 %		2.40 $\pm$ 5 %	
3500	37.9 $\pm$ 5 %		2.91 $\pm$ 5 %	

### 7.2 SAR MEASUREMENT RESULT WITH HEAD LIQUID

The IEEE Std. 1528 and CEI/IEC 62209 standards state that the system validation measurements should produce the SAR values shown below (for phantom thickness of 2 mm), within the uncertainty for the system validation. All SAR values are normalized to 1 W forward power. In bracket, the measured SAR is given with the used input power.

Software	OPENSAR V4
Phantom	SN 20/09 SAM71
Probe	SN 18/11 EPG122
Liquid	Head Liquid Values: $\epsilon_r'$ : 42.5 $\sigma$ : 0.96
Distance between dipole center and liquid	15.0 mm
Area scan resolution	dx=8mm/dy=8mm

Page: 7/11

*This document shall not be reproduced, except in full or in part, without the written approval of SATIMO. The information contained herein is to be used only for the purpose for which it is submitted and is not to be released in whole or part without written approval of SATIMO.*



SAR REFERENCE DIPOLE CALIBRATION REPORT

Ref: ACR.287.5.14.SATU.A

Zoon Scan Resolution	dx=8mm/dy=8m/dz=5mm
Frequency	900 MHz
Input power	20 dBm
Liquid Temperature	21 °C
Lab Temperature	21 °C
Lab Humidity	45 %

Frequency MHz	1 g SAR (W/kg/W)		10 g SAR (W/kg/W)	
	required	measured	required	measured
300	2.85		1.94	
450	4.58		3.06	
750	8.49		5.55	
835	9.56		6.22	
900	10.9	11.12 (1.11)	6.99	7.01 (0.70)
1450	29		16	
1500	30.5		16.8	
1640	34.2		18.4	
1750	36.4		19.3	
1800	38.4		20.1	
1900	39.7		20.5	
1950	40.5		20.9	
2000	41.1		21.1	
2100	43.6		21.9	
2300	48.7		23.3	
2450	52.4		24	
2600	55.3		24.6	
3000	63.8		25.7	
3500	67.1		25	

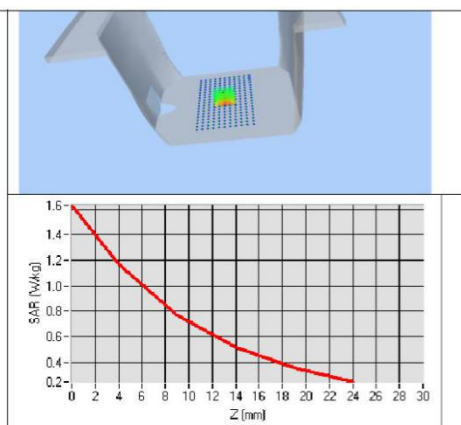
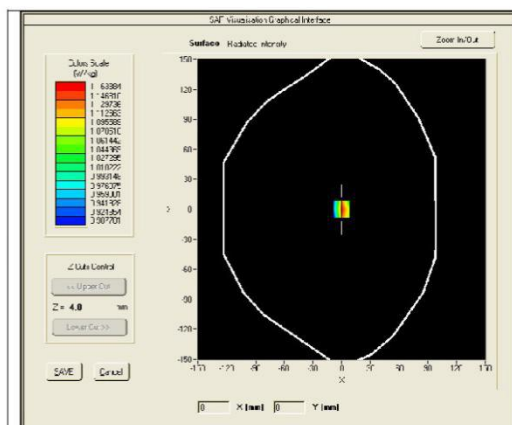

*This document shall not be reproduced, except in full or in part, without the written approval of SATIMO. The information contained herein is to be used only for the purpose for which it is submitted and is not to be released in whole or part without written approval of SATIMO.*



## SAR REFERENCE DIPOLE CALIBRATION REPORT

Ref: ACR.287.5.14.SATU.A

## 7.3 BODY LIQUID MEASUREMENT

Frequency MHz	Relative permittivity ( $\epsilon_r'$ )		Conductivity ( $\sigma$ ) S/m	
	required	measured	required	measured
150	61.9 $\pm$ 5 %		0.80 $\pm$ 5 %	
300	58.2 $\pm$ 5 %		0.92 $\pm$ 5 %	
450	56.7 $\pm$ 5 %		0.94 $\pm$ 5 %	
750	55.5 $\pm$ 5 %		0.96 $\pm$ 5 %	
835	55.2 $\pm$ 5 %		0.97 $\pm$ 5 %	
900	55.0 $\pm$ 5 %	PASS	1.05 $\pm$ 5 %	PASS
915	55.0 $\pm$ 5 %		1.06 $\pm$ 5 %	
1450	54.0 $\pm$ 5 %		1.30 $\pm$ 5 %	
1610	53.8 $\pm$ 5 %		1.40 $\pm$ 5 %	
1800	53.3 $\pm$ 5 %		1.52 $\pm$ 5 %	
1900	53.3 $\pm$ 5 %		1.52 $\pm$ 5 %	
2000	53.3 $\pm$ 5 %		1.52 $\pm$ 5 %	
2100	53.2 $\pm$ 5 %		1.62 $\pm$ 5 %	
2450	52.7 $\pm$ 5 %		1.95 $\pm$ 5 %	
2600	52.5 $\pm$ 5 %		2.16 $\pm$ 5 %	
3000	52.0 $\pm$ 5 %		2.73 $\pm$ 5 %	
3500	51.3 $\pm$ 5 %		3.31 $\pm$ 5 %	
5200	49.0 $\pm$ 10 %		5.30 $\pm$ 10 %	
5300	48.9 $\pm$ 10 %		5.42 $\pm$ 10 %	
5400	48.7 $\pm$ 10 %		5.53 $\pm$ 10 %	
5500	48.6 $\pm$ 10 %		5.65 $\pm$ 10 %	
5600	48.5 $\pm$ 10 %		5.77 $\pm$ 10 %	
5800	48.2 $\pm$ 10 %		6.00 $\pm$ 10 %	

## 7.4 SAR MEASUREMENT RESULT WITH BODY LIQUID

Software	OPENSAR V4
Phantom	SN 20/09 SAM71
Probe	SN 18/11 EPG122
Liquid	Body Liquid Values: $\epsilon_r'$ : 56.7 sigma : 1.08
Distance between dipole center and liquid	15.0 mm
Area scan resolution	dx=8mm/dy=8mm
Zoon Scan Resolution	dx=8mm/dy=8m/dz=5mm
Frequency	900 MHz
Input power	20 dBm
Liquid Temperature	21 °C
Lab Temperature	21 °C
Lab Humidity	45 %

Page: 9/11

*This document shall not be reproduced, except in full or in part, without the written approval of SATIMO.  
The information contained herein is to be used only for the purpose for which it is submitted and is not to be released in whole or part without written approval of SATIMO.*





SAR REFERENCE DIPOLE CALIBRATION REPORT

Ref: ACR.287.5.14.SATU.A

Frequency MHz	1 g SAR (W/kg/W)	10 g SAR (W/kg/W)
	measured	measured
900	11.34 (1.13)	7.15 (0.72)

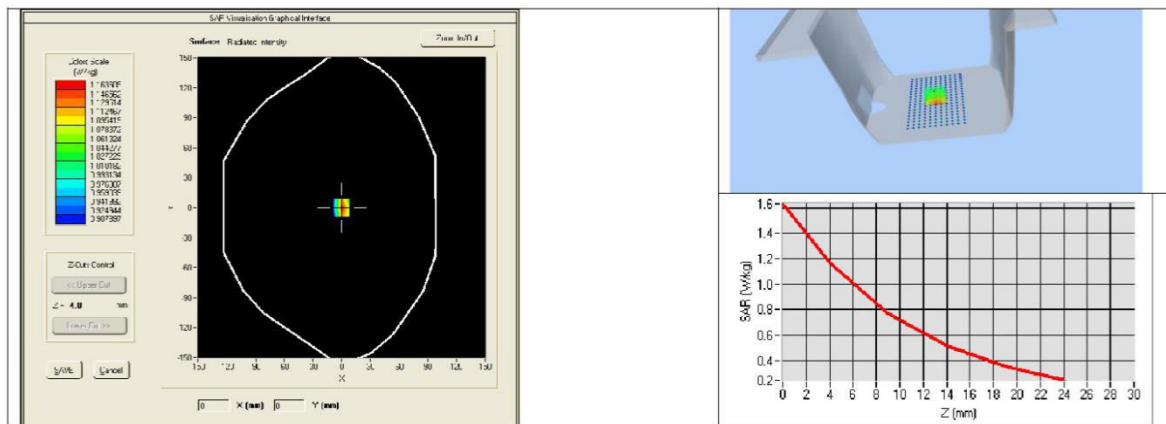

*This document shall not be reproduced, except in full or in part, without the written approval of SATIMO. The information contained herein is to be used only for the purpose for which it is submitted and is not to be released in whole or part without written approval of SATIMO.*



## SAR REFERENCE DIPOLE CALIBRATION REPORT

Ref: ACR.287.5.14.SATU.A

## 8 LIST OF EQUIPMENT

Equipment Summary Sheet				
Equipment Description	Manufacturer / Model	Identification No.	Current Calibration Date	Next Calibration Date
SAM Phantom	Satimo	SN-20/09-SAM71	Validated. No cal required.	Validated. No cal required.
COMOSAR Test Bench	Version 3	NA	Validated. No cal required.	Validated. No cal required.
Network Analyzer	Rhode & Schwarz ZVA	SN100132	02/2016	02/2019
Calipers	Carrera	CALIPER-01	12/2016	12/2019
Reference Probe	Satimo	EPG122 SN 18/11	10/2018	10/2019
Multimeter	Keithley 2000	1188656	12/2016	12/2019
Signal Generator	Agilent E4438C	MY49070581	12/2016	12/2019
Amplifier	Aethercomm	SN 046	Characterized prior to test. No cal required.	Characterized prior to test. No cal required.
Power Meter	HP E4418A	US38261498	12/2016	12/2019
Power Sensor	HP ECP-E26A	US37181460	12/2016	12/2019
Directional Coupler	Narda 4216-20	01386	Characterized prior to test. No cal required.	Characterized prior to test. No cal required.
Temperature and Humidity Sensor	Control Company	11-661-9	8/2016	8/2019

Page: 11/11

*This document shall not be reproduced, except in full or in part, without the written approval of SATIMO. The information contained herein is to be used only for the purpose for which it is submitted and is not to be released in whole or part without written approval of SATIMO.*

## 5.3 SID1800 Dipole Calibration Certificate



### SAR Reference Dipole Calibration Report

Ref : ACR.287.6.14.SATU.A

**SHENZHEN LCS COMPLIANCE TESTING  
LABORATORY LTD.**

**1F., XINGYUAN INDUSTRIAL PARK, TONGDA ROAD,  
BAO'AN BLVD**

**BAO'AN DISTRICT, SHENZHEN, GUANGDONG, CHINA**

**SATIMO COMOSAR REFERENCE DIPOLE**

**FREQUENCY: 1800 MHZ**

**SERIAL NO.: SN 07/14 DIP 1G800-301**

**Calibrated at SATIMO US**

**2105 Barrett Park Dr. - Kennesaw, GA 30144**



**10/01/2018**

*Summary:*

This document presents the method and results from an accredited SAR reference dipole calibration performed in SATIMO USA using the COMOSAR test bench. All calibration results are traceable to national metrology institutions.



## SAR REFERENCE DIPOLE CALIBRATION REPORT

Ref: ACR.287.6.14.SATU.A

	<i>Name</i>	<i>Function</i>	<i>Date</i>	<i>Signature</i>
<i>Prepared by :</i>	Jérôme LUC	Product Manager	10/14/2018	<i>JS</i>
<i>Checked by :</i>	Jérôme LUC	Product Manager	10/14/2018	<i>JS</i>
<i>Approved by :</i>	Kim RUTKOWSKI	Quality Manager	10/14/2018	<i>Kim Rutkowski</i>

	<i>Customer Name</i>
<i>Distribution :</i>	Shenzhen LCS Compliance Testing Laboratory Ltd.

<i>Issue</i>	<i>Date</i>	<i>Modifications</i>
A	10/14/2018	Initial release

Page: 2/11

*This document shall not be reproduced, except in full or in part, without the written approval of SATIMO.  
The information contained herein is to be used only for the purpose for which it is submitted and is not to  
be released in whole or part without written approval of SATIMO.*



## TABLE OF CONTENTS

1	Introduction.....	4
2	Device Under Test .....	4
3	Product Description .....	4
3.1	General Information .....	4
4	Measurement Method .....	5
4.1	Return Loss Requirements .....	5
4.2	Mechanical Requirements .....	5
5	Measurement Uncertainty .....	5
5.1	Return Loss .....	5
5.2	Dimension Measurement .....	5
5.3	Validation Measurement .....	5
6	Calibration Measurement Results .....	6
6.1	Return Loss and Impedance .....	6
6.2	Mechanical Dimensions .....	6
7	Validation measurement .....	7
7.1	Head Liquid Measurement .....	7
7.2	SAR Measurement Result With Head Liquid .....	7
7.3	Body Liquid Measurement .....	9
7.4	SAR Measurement Result With Body Liquid .....	9
8	List of Equipment .....	11

Page: 3/11

*This document shall not be reproduced, except in full or in part, without the written approval of SATIMO.  
The information contained herein is to be used only for the purpose for which it is submitted and is not to be released in whole or part without written approval of SATIMO.*



## 1 INTRODUCTION

This document contains a summary of the requirements set forth by the IEEE 1528, OET 65 Bulletin C and CEI/IEC 62209 standards for reference dipoles used for SAR measurement system validations and the measurements that were performed to verify that the product complies with the fore mentioned standards.

## 2 DEVICE UNDER TEST

Device Under Test	
Device Type	COMOSAR 1800 MHz REFERENCE DIPOLE
Manufacturer	Satimo
Model	SID1800
Serial Number	SN 07/14 DIP 1G800-301
Product Condition (new / used)	New

A yearly calibration interval is recommended.

## 3 PRODUCT DESCRIPTION

### 3.1 GENERAL INFORMATION

Satimo's COMOSAR Validation Dipoles are built in accordance to the IEEE 1528, OET 65 Bulletin C and CEI/IEC 62209 standards. The product is designed for use with the COMOSAR test bench only.



**Figure 1** – Satimo COMOSAR Validation Dipole

Page: 4/11

*This document shall not be reproduced, except in full or in part, without the written approval of SATIMO. The information contained herein is to be used only for the purpose for which it is submitted and is not to be released in whole or part without written approval of SATIMO.*



#### 4 MEASUREMENT METHOD

The IEEE 1528, OET 65 Bulletin C and CEI/IEC 62209 standards provide requirements for reference dipoles used for system validation measurements. The following measurements were performed to verify that the product complies with the fore mentioned standards.

##### 4.1 RETURN LOSS REQUIREMENTS

The dipole used for SAR system validation measurements and checks must have a return loss of -20 dB or better. The return loss measurement shall be performed against a liquid filled flat phantom, with the phantom constructed as outlined in the fore mentioned standards.

##### 4.2 MECHANICAL REQUIREMENTS

The IEEE Std. 1528 and CEI/IEC 62209 standards specify the mechanical components and dimensions of the validation dipoles, with the dimensions frequency and phantom shell thickness dependent. The COMOSAR test bench employs a 2 mm phantom shell thickness therefore the dipoles sold for use with the COMOSAR test bench comply with the requirements set forth for a 2 mm phantom shell thickness.

#### 5 MEASUREMENT UNCERTAINTY

All uncertainties listed below represent an expanded uncertainty expressed at approximately the 95% confidence level using a coverage factor of  $k=2$ , traceable to the Internationally Accepted Guides to Measurement Uncertainty.

##### 5.1 RETURN LOSS

The following uncertainties apply to the return loss measurement:

Frequency band	Expanded Uncertainty on Return Loss
400-6000MHz	0.1 dB

##### 5.2 DIMENSION MEASUREMENT

The following uncertainties apply to the dimension measurements:

Length (mm)	Expanded Uncertainty on Length
3 - 300	0.05 mm

##### 5.3 VALIDATION MEASUREMENT

The guidelines outlined in the IEEE 1528, OET 65 Bulletin C, CENELEC EN50361 and CEI/IEC 62209 standards were followed to generate the measurement uncertainty for validation measurements.

Scan Volume	Expanded Uncertainty
1 g	20.3 %
10 g	20.1 %

Page: 5/11

*This document shall not be reproduced, except in full or in part, without the written approval of SATIMO. The information contained herein is to be used only for the purpose for which it is submitted and is not to be released in whole or part without written approval of SATIMO.*



## SAR REFERENCE DIPOLE CALIBRATION REPORT

Ref: ACR.287.6.14.SATU.A

## 7 VALIDATION MEASUREMENT

The IEEE Std. 1528, OET 65 Bulletin C and CEI/IEC 62209 standards state that the system validation measurements must be performed using a reference dipole meeting the fore mentioned return loss and mechanical dimension requirements. The validation measurement must be performed against a liquid filled flat phantom, with the phantom constructed as outlined in the fore mentioned standards. Per the standards, the dipole shall be positioned below the bottom of the phantom, with the dipole length centered and parallel to the longest dimension of the flat phantom, with the top surface of the dipole at the described distance from the bottom surface of the phantom.

### 7.1 HEAD LIQUID MEASUREMENT

Frequency MHz	Relative permittivity ( $\epsilon_r'$ )		Conductivity ( $\sigma$ ) S/m	
	required	measured	required	measured
300	45.3 $\pm$ 5 %		0.87 $\pm$ 5 %	
450	43.5 $\pm$ 5 %		0.87 $\pm$ 5 %	
750	41.9 $\pm$ 5 %		0.89 $\pm$ 5 %	
835	41.5 $\pm$ 5 %		0.90 $\pm$ 5 %	
900	41.5 $\pm$ 5 %		0.97 $\pm$ 5 %	
1450	40.5 $\pm$ 5 %		1.20 $\pm$ 5 %	
1500	40.4 $\pm$ 5 %		1.23 $\pm$ 5 %	
1640	40.2 $\pm$ 5 %		1.31 $\pm$ 5 %	
1750	40.1 $\pm$ 5 %		1.37 $\pm$ 5 %	
1800	40.0 $\pm$ 5 %	PASS	1.40 $\pm$ 5 %	PASS
1900	40.0 $\pm$ 5 %		1.40 $\pm$ 5 %	
1950	40.0 $\pm$ 5 %		1.40 $\pm$ 5 %	
2000	40.0 $\pm$ 5 %		1.40 $\pm$ 5 %	
2100	39.8 $\pm$ 5 %		1.49 $\pm$ 5 %	
2300	39.5 $\pm$ 5 %		1.67 $\pm$ 5 %	
2450	39.2 $\pm$ 5 %		1.80 $\pm$ 5 %	
2600	39.0 $\pm$ 5 %		1.96 $\pm$ 5 %	
3000	38.5 $\pm$ 5 %		2.40 $\pm$ 5 %	
3500	37.9 $\pm$ 5 %		2.91 $\pm$ 5 %	

### 7.2 SAR MEASUREMENT RESULT WITH HEAD LIQUID

The IEEE Std. 1528 and CEI/IEC 62209 standards state that the system validation measurements should produce the SAR values shown below (for phantom thickness of 2 mm), within the uncertainty for the system validation. All SAR values are normalized to 1 W forward power. In bracket, the measured SAR is given with the used input power.

Software	OPENSAR V4
Phantom	SN 20/09 SAM71
Probe	SN 18/11 EPG122
Liquid	Head Liquid Values: $\epsilon_r'$ : 41.3 $\sigma$ : 1.38
Distance between dipole center and liquid	10.0 mm
Area scan resolution	$dx=8mm/dy=8mm$

Page: 7/11

*This document shall not be reproduced, except in full or in part, without the written approval of SATIMO. The information contained herein is to be used only for the purpose for which it is submitted and is not to be released in whole or part without written approval of SATIMO.*





SAR REFERENCE DIPOLE CALIBRATION REPORT

Ref: ACR.287.6.14.SATU.A

Zoon Scan Resolution	dx=8mm/dy=8m/dz=5mm
Frequency	1800 MHz
Input power	20 dBm
Liquid Temperature	21 °C
Lab Temperature	21 °C
Lab Humidity	45 %

Frequency MHz	1 g SAR (W/kg/W)		10 g SAR (W/kg/W)	
	required	measured	required	measured
300	2.85		1.94	
450	4.58		3.06	
750	8.49		5.55	
835	9.56		6.22	
900	10.9		6.99	
1450	29		16	
1500	30.5		16.8	
1640	34.2		18.4	
1750	36.4		19.3	
1800	38.4	38.13 (3.81)	20.1	20.20 (2.02)
1900	39.7		20.5	
1950	40.5		20.9	
2000	41.1		21.1	
2100	43.6		21.9	
2300	48.7		23.3	
2450	52.4		24	
2600	55.3		24.6	
3000	63.8		25.7	
3500	67.1		25	

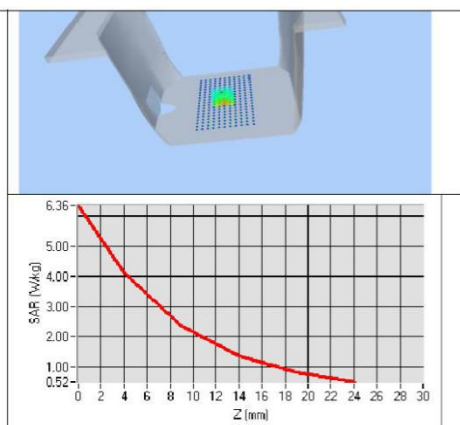
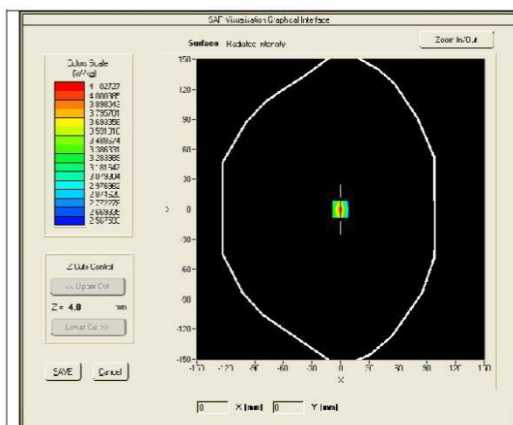

*This document shall not be reproduced, except in full or in part, without the written approval of SATIMO. The information contained herein is to be used only for the purpose for which it is submitted and is not to be released in whole or part without written approval of SATIMO.*



## SAR REFERENCE DIPOLE CALIBRATION REPORT

Ref: ACR.287.6.14.SATU.A

## 8 LIST OF EQUIPMENT

Equipment Summary Sheet				
Equipment Description	Manufacturer / Model	Identification No.	Current Calibration Date	Next Calibration Date
SAM Phantom	Satimo	SN-20/09-SAM71	Validated. No cal required.	Validated. No cal required.
COMOSAR Test Bench	Version 3	NA	Validated. No cal required.	Validated. No cal required.
Network Analyzer	Rhode & Schwarz ZVA	SN100132	02/2016	02/2019
Calipers	Carrera	CALIPER-01	12/2016	12/2019
Reference Probe	Satimo	EPG122 SN 18/11	10/2018	10/2019
Multimeter	Keithley 2000	1188656	12/2016	12/2019
Signal Generator	Agilent E4438C	MY49070581	12/2016	12/2019
Amplifier	Aethercomm	SN 046	Characterized prior to test. No cal required.	Characterized prior to test. No cal required.
Power Meter	HP E4418A	US38261498	12/2016	12/2019
Power Sensor	HP ECP-E26A	US37181460	12/2016	12/2019
Directional Coupler	Narda 4216-20	01386	Characterized prior to test. No cal required.	Characterized prior to test. No cal required.
Temperature and Humidity Sensor	Control Company	11-661-9	8/2016	8/2019

Page: 11/11

*This document shall not be reproduced, except in full or in part, without the written approval of SATIMO. The information contained herein is to be used only for the purpose for which it is submitted and is not to be released in whole or part without written approval of SATIMO.*

## 5.4 SID2000 Dipole Calibration Certificate



### SAR Reference Dipole Calibration Report

Ref : ACR.287.7.14.SATU.A

**SHENZHEN LCS COMPLIANCE TESTING  
LABORATORY LTD.**

**1F., XINGYUAN INDUSTRIAL PARK, TONGDA ROAD,  
BAO'AN BLVD**

**BAO'AN DISTRICT, SHENZHEN, GUANGDONG, CHINA**

**SATIMO COMOSAR REFERENCE DIPOLE**

**FREQUENCY: 2000 MHZ**

**SERIAL NO.: SN 07/14 DIP 2G000-305**

**Calibrated at SATIMO US**

**2105 Barrett Park Dr. - Kennesaw, GA 30144**



**10/01/2018**

*Summary:*

This document presents the method and results from an accredited SAR reference dipole calibration performed in SATIMO USA using the COMOSAR test bench. All calibration results are traceable to national metrology institutions.



## SAR REFERENCE DIPOLE CALIBRATION REPORT

Ref: ACR.287.7.14.SATU.A

	<i>Name</i>	<i>Function</i>	<i>Date</i>	<i>Signature</i>
<i>Prepared by :</i>	Jérôme LUC	Product Manager	10/14/2018	<i>JS</i>
<i>Checked by :</i>	Jérôme LUC	Product Manager	10/14/2018	<i>JS</i>
<i>Approved by :</i>	Kim RUTKOWSKI	Quality Manager	10/14/2018	<i>Kim Rutkowski</i>

	<i>Customer Name</i>
<i>Distribution :</i>	Shenzhen LCS Compliance Testing Laboratory Ltd.

<i>Issue</i>	<i>Date</i>	<i>Modifications</i>
A	10/14/2018	Initial release

Page: 2/11

*This document shall not be reproduced, except in full or in part, without the written approval of SATIMO.  
The information contained herein is to be used only for the purpose for which it is submitted and is not to  
be released in whole or part without written approval of SATIMO.*



## TABLE OF CONTENTS

1	Introduction.....	4
2	Device Under Test .....	4
3	Product Description .....	4
3.1	General Information .....	4
4	Measurement Method .....	5
4.1	Return Loss Requirements .....	5
4.2	Mechanical Requirements .....	5
5	Measurement Uncertainty .....	5
5.1	Return Loss .....	5
5.2	Dimension Measurement .....	5
5.3	Validation Measurement .....	5
6	Calibration Measurement Results .....	6
6.1	Return Loss and Impedance .....	6
6.2	Mechanical Dimensions .....	6
7	Validation measurement .....	7
7.1	Head Liquid Measurement .....	7
7.2	SAR Measurement Result With Head Liquid .....	7
7.3	Body Liquid Measurement .....	9
7.4	SAR Measurement Result With Body Liquid .....	9
8	List of Equipment .....	11

Page: 3/11

*This document shall not be reproduced, except in full or in part, without the written approval of SATIMO.  
The information contained herein is to be used only for the purpose for which it is submitted and is not to be released in whole or part without written approval of SATIMO.*



## SAR REFERENCE DIPOLE CALIBRATION REPORT

Ref: ACR.287.7.14.SATU.A

## 1 INTRODUCTION

This document contains a summary of the requirements set forth by the IEEE 1528, OET 65 Bulletin C and CEI/IEC 62209 standards for reference dipoles used for SAR measurement system validations and the measurements that were performed to verify that the product complies with the fore mentioned standards.

## 2 DEVICE UNDER TEST

Device Under Test	
Device Type	COMOSAR 2000 MHz REFERENCE DIPOLE
Manufacturer	Satimo
Model	SID2000
Serial Number	SN 07/14 DIP 2G000-305
Product Condition (new / used)	New

A yearly calibration interval is recommended.

## 3 PRODUCT DESCRIPTION

### 3.1 GENERAL INFORMATION

Satimo's COMOSAR Validation Dipoles are built in accordance to the IEEE 1528, OET 65 Bulletin C and CEI/IEC 62209 standards. The product is designed for use with the COMOSAR test bench only.



**Figure 1** – Satimo COMOSAR Validation Dipole

Page: 4/11

*This document shall not be reproduced, except in full or in part, without the written approval of SATIMO. The information contained herein is to be used only for the purpose for which it is submitted and is not to be released in whole or part without written approval of SATIMO.*



#### 4 MEASUREMENT METHOD

The IEEE 1528, OET 65 Bulletin C and CEI/IEC 62209 standards provide requirements for reference dipoles used for system validation measurements. The following measurements were performed to verify that the product complies with the fore mentioned standards.

##### 4.1 RETURN LOSS REQUIREMENTS

The dipole used for SAR system validation measurements and checks must have a return loss of -20 dB or better. The return loss measurement shall be performed against a liquid filled flat phantom, with the phantom constructed as outlined in the fore mentioned standards.

##### 4.2 MECHANICAL REQUIREMENTS

The IEEE Std. 1528 and CEI/IEC 62209 standards specify the mechanical components and dimensions of the validation dipoles, with the dimensions frequency and phantom shell thickness dependent. The COMOSAR test bench employs a 2 mm phantom shell thickness therefore the dipoles sold for use with the COMOSAR test bench comply with the requirements set forth for a 2 mm phantom shell thickness.

#### 5 MEASUREMENT UNCERTAINTY

All uncertainties listed below represent an expanded uncertainty expressed at approximately the 95% confidence level using a coverage factor of k=2, traceable to the Internationally Accepted Guides to Measurement Uncertainty.

##### 5.1 RETURN LOSS

The following uncertainties apply to the return loss measurement:

Frequency band	Expanded Uncertainty on Return Loss
400-6000MHz	0.1 dB

##### 5.2 DIMENSION MEASUREMENT

The following uncertainties apply to the dimension measurements:

Length (mm)	Expanded Uncertainty on Length
3 - 300	0.05 mm

##### 5.3 VALIDATION MEASUREMENT

The guidelines outlined in the IEEE 1528, OET 65 Bulletin C, CENELEC EN50361 and CEI/IEC 62209 standards were followed to generate the measurement uncertainty for validation measurements.

Scan Volume	Expanded Uncertainty
1 g	20.3 %
10 g	20.1 %

Page: 5/11

*This document shall not be reproduced, except in full or in part, without the written approval of SATIMO. The information contained herein is to be used only for the purpose for which it is submitted and is not to be released in whole or part without written approval of SATIMO.*



## SAR REFERENCE DIPOLE CALIBRATION REPORT

Ref: ACR.287.7.14.SATU.A

## 6 CALIBRATION MEASUREMENT RESULTS

### 6.1 RETURN LOSS AND IMPEDANCE

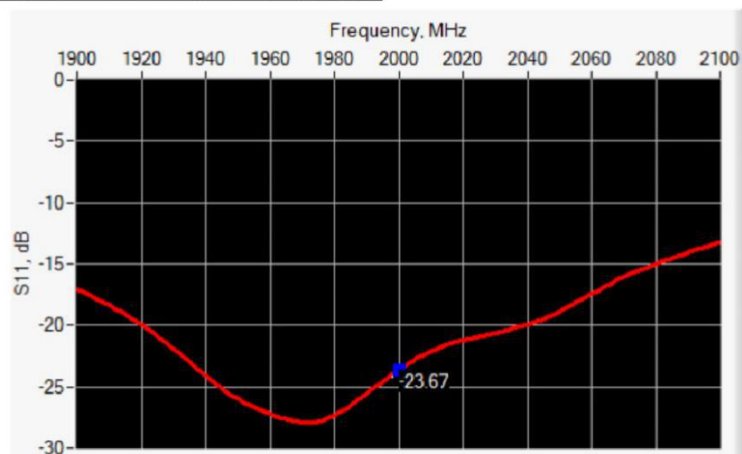

Frequency (MHz)	Return Loss (dB)	Requirement (dB)	Impedance
2000	-23.67	-20	50.8 $\Omega$ - 6.2 j $\Omega$

### 6.2 MECHANICAL DIMENSIONS

Frequency MHz	L mm		h mm		d mm	
	required	measured	required	measured	required	measured
300	420.0 $\pm$ 1 %.		250.0 $\pm$ 1 %.		6.35 $\pm$ 1 %.	
450	290.0 $\pm$ 1 %.		166.7 $\pm$ 1 %.		6.35 $\pm$ 1 %.	
750	176.0 $\pm$ 1 %.		100.0 $\pm$ 1 %.		6.35 $\pm$ 1 %.	
835	161.0 $\pm$ 1 %.		89.8 $\pm$ 1 %.		3.6 $\pm$ 1 %.	
900	149.0 $\pm$ 1 %.		83.3 $\pm$ 1 %.		3.6 $\pm$ 1 %.	
1450	89.1 $\pm$ 1 %.		51.7 $\pm$ 1 %.		3.6 $\pm$ 1 %.	
1500	80.5 $\pm$ 1 %.		50.0 $\pm$ 1 %.		3.6 $\pm$ 1 %.	
1640	79.0 $\pm$ 1 %.		45.7 $\pm$ 1 %.		3.6 $\pm$ 1 %.	
1750	75.2 $\pm$ 1 %.		42.9 $\pm$ 1 %.		3.6 $\pm$ 1 %.	
1800	72.0 $\pm$ 1 %.		41.7 $\pm$ 1 %.		3.6 $\pm$ 1 %.	
1900	68.0 $\pm$ 1 %.		39.5 $\pm$ 1 %.		3.6 $\pm$ 1 %.	
1950	66.3 $\pm$ 1 %.		38.5 $\pm$ 1 %.		3.6 $\pm$ 1 %.	
2000	64.5 $\pm$ 1 %.	PASS	37.5 $\pm$ 1 %.	PASS	3.6 $\pm$ 1 %.	PASS
2100	61.0 $\pm$ 1 %.		35.7 $\pm$ 1 %.		3.6 $\pm$ 1 %.	
2300	55.5 $\pm$ 1 %.		32.6 $\pm$ 1 %.		3.6 $\pm$ 1 %.	
2450	51.5 $\pm$ 1 %.		30.4 $\pm$ 1 %.		3.6 $\pm$ 1 %.	
2600	48.5 $\pm$ 1 %.		28.8 $\pm$ 1 %.		3.6 $\pm$ 1 %.	
3000	41.5 $\pm$ 1 %.		25.0 $\pm$ 1 %.		3.6 $\pm$ 1 %.	
3500	37.0 $\pm$ 1 %.		26.4 $\pm$ 1 %.		3.6 $\pm$ 1 %.	
3700	34.7 $\pm$ 1 %.		26.4 $\pm$ 1 %.		3.6 $\pm$ 1 %.	

Page: 6/11

*This document shall not be reproduced, except in full or in part, without the written approval of SATIMO. The information contained herein is to be used only for the purpose for which it is submitted and is not to be released in whole or part without written approval of SATIMO.*





## 7 VALIDATION MEASUREMENT

The IEEE Std. 1528, OET 65 Bulletin C and CEI/IEC 62209 standards state that the system validation measurements must be performed using a reference dipole meeting the fore mentioned return loss and mechanical dimension requirements. The validation measurement must be performed against a liquid filled flat phantom, with the phantom constructed as outlined in the fore mentioned standards. Per the standards, the dipole shall be positioned below the bottom of the phantom, with the dipole length centered and parallel to the longest dimension of the flat phantom, with the top surface of the dipole at the described distance from the bottom surface of the phantom.

### 7.1 HEAD LIQUID MEASUREMENT

Frequency MHz	Relative permittivity ( $\epsilon_r'$ )		Conductivity ( $\sigma$ ) S/m	
	required	measured	required	measured
300	45.3 $\pm$ 5 %		0.87 $\pm$ 5 %	
450	43.5 $\pm$ 5 %		0.87 $\pm$ 5 %	
750	41.9 $\pm$ 5 %		0.89 $\pm$ 5 %	
835	41.5 $\pm$ 5 %		0.90 $\pm$ 5 %	
900	41.5 $\pm$ 5 %		0.97 $\pm$ 5 %	
1450	40.5 $\pm$ 5 %		1.20 $\pm$ 5 %	
1500	40.4 $\pm$ 5 %		1.23 $\pm$ 5 %	
1640	40.2 $\pm$ 5 %		1.31 $\pm$ 5 %	
1750	40.1 $\pm$ 5 %		1.37 $\pm$ 5 %	
1800	40.0 $\pm$ 5 %		1.40 $\pm$ 5 %	
1900	40.0 $\pm$ 5 %		1.40 $\pm$ 5 %	
1950	40.0 $\pm$ 5 %		1.40 $\pm$ 5 %	
2000	40.0 $\pm$ 5 %	PASS	1.40 $\pm$ 5 %	PASS
2100	39.8 $\pm$ 5 %		1.49 $\pm$ 5 %	
2300	39.5 $\pm$ 5 %		1.67 $\pm$ 5 %	
2450	39.2 $\pm$ 5 %		1.80 $\pm$ 5 %	
2600	39.0 $\pm$ 5 %		1.96 $\pm$ 5 %	
3000	38.5 $\pm$ 5 %		2.40 $\pm$ 5 %	
3500	37.9 $\pm$ 5 %		2.91 $\pm$ 5 %	

### 7.2 SAR MEASUREMENT RESULT WITH HEAD LIQUID

The IEEE Std. 1528 and CEI/IEC 62209 standards state that the system validation measurements should produce the SAR values shown below (for phantom thickness of 2 mm), within the uncertainty for the system validation. All SAR values are normalized to 1 W forward power. In bracket, the measured SAR is given with the used input power.

Software	OPENSAR V4
Phantom	SN 20/09 SAM71
Probe	SN 18/11 EPG122
Liquid	Head Liquid Values: $\epsilon_r'$ : 39.7 sigma : 1.43
Distance between dipole center and liquid	10.0 mm
Area scan resolution	dx=8mm/dy=8mm

Page: 7/11

*This document shall not be reproduced, except in full or in part, without the written approval of SATIMO.  
The information contained herein is to be used only for the purpose for which it is submitted and is not to be released in whole or part without written approval of SATIMO.*



SAR REFERENCE DIPOLE CALIBRATION REPORT

Ref: ACR.287.7.14.SATU.A

Zoon Scan Resolution	dx=8mm/dy=8m/dz=5mm
Frequency	2000 MHz
Input power	20 dBm
Liquid Temperature	21 °C
Lab Temperature	21 °C
Lab Humidity	45 %

Frequency MHz	1 g SAR (W/kg/W)		10 g SAR (W/kg/W)	
	required	measured	required	measured
300	2.85		1.94	
450	4.58		3.06	
750	8.49		5.55	
835	9.56		6.22	
900	10.9		6.99	
1450	29		16	
1500	30.5		16.8	
1640	34.2		18.4	
1750	36.4		19.3	
1800	38.4		20.1	
1900	39.7		20.5	
1950	40.5		20.9	
2000	41.1	43.00 (4.30)	21.1	21.20 (2.12)
2100	43.6		21.9	
2300	48.7		23.3	
2450	52.4		24	
2600	55.3		24.6	
3000	63.8		25.7	
3500	67.1		25	

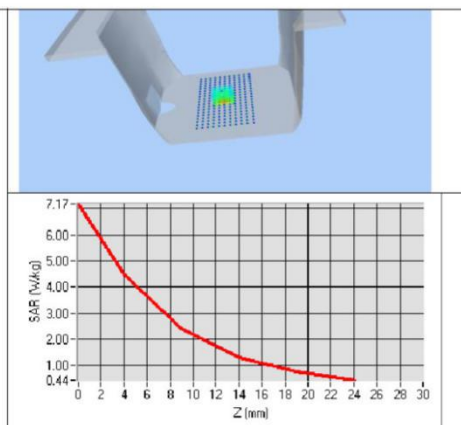
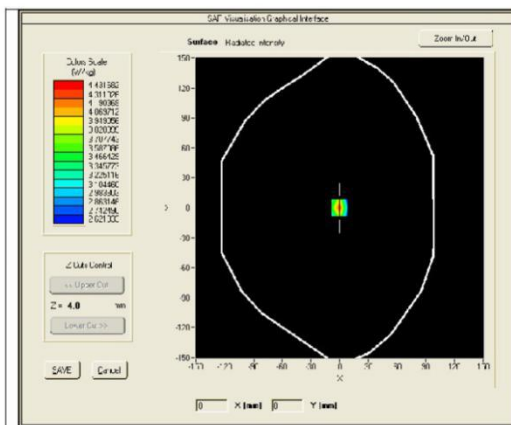

*This document shall not be reproduced, except in full or in part, without the written approval of SATIMO. The information contained herein is to be used only for the purpose for which it is submitted and is not to be released in whole or part without written approval of SATIMO.*



## SAR REFERENCE DIPOLE CALIBRATION REPORT

Ref: ACR.287.7.14.SATU.A

## 7.3 BODY LIQUID MEASUREMENT

Frequency MHz	Relative permittivity ( $\epsilon_r$ )		Conductivity ( $\sigma$ ) S/m	
	required	measured	required	measured
150	61.9 $\pm$ 5 %		0.80 $\pm$ 5 %	
300	58.2 $\pm$ 5 %		0.92 $\pm$ 5 %	
450	56.7 $\pm$ 5 %		0.94 $\pm$ 5 %	
750	55.5 $\pm$ 5 %		0.96 $\pm$ 5 %	
835	55.2 $\pm$ 5 %		0.97 $\pm$ 5 %	
900	55.0 $\pm$ 5 %		1.05 $\pm$ 5 %	
915	55.0 $\pm$ 5 %		1.06 $\pm$ 5 %	
1450	54.0 $\pm$ 5 %		1.30 $\pm$ 5 %	
1610	53.8 $\pm$ 5 %		1.40 $\pm$ 5 %	
1800	53.3 $\pm$ 5 %		1.52 $\pm$ 5 %	
1900	53.3 $\pm$ 5 %		1.52 $\pm$ 5 %	
2000	53.3 $\pm$ 5 %	PASS	1.52 $\pm$ 5 %	PASS
2100	53.2 $\pm$ 5 %		1.62 $\pm$ 5 %	
2450	52.7 $\pm$ 5 %		1.95 $\pm$ 5 %	
2600	52.5 $\pm$ 5 %		2.16 $\pm$ 5 %	
3000	52.0 $\pm$ 5 %		2.73 $\pm$ 5 %	
3500	51.3 $\pm$ 5 %		3.31 $\pm$ 5 %	
5200	49.0 $\pm$ 10 %		5.30 $\pm$ 10 %	
5300	48.9 $\pm$ 10 %		5.42 $\pm$ 10 %	
5400	48.7 $\pm$ 10 %		5.53 $\pm$ 10 %	
5500	48.6 $\pm$ 10 %		5.65 $\pm$ 10 %	
5600	48.5 $\pm$ 10 %		5.77 $\pm$ 10 %	
5800	48.2 $\pm$ 10 %		6.00 $\pm$ 10 %	

## 7.4 SAR MEASUREMENT RESULT WITH BODY LIQUID

Software	OPENSAR V4
Phantom	SN 20/09 SAM71
Probe	SN 18/11 EPG122
Liquid	Body Liquid Values: $\epsilon_r$ : 53.9 sigma : 1.53
Distance between dipole center and liquid	10.0 mm
Area scan resolution	dx=8mm/dy=8mm
Zoon Scan Resolution	dx=8mm/dy=8m/dz=5mm
Frequency	2000 MHz
Input power	20 dBm
Liquid Temperature	21 °C
Lab Temperature	21 °C
Lab Humidity	45 %

Page: 9/11

*This document shall not be reproduced, except in full or in part, without the written approval of SATIMO.  
The information contained herein is to be used only for the purpose for which it is submitted and is not to be released in whole or part without written approval of SATIMO.*



SAR REFERENCE DIPOLE CALIBRATION REPORT

Ref: ACR.287.7.14.SATU.A

Frequency MHz	1 g SAR (W/kg/W)	10 g SAR (W/kg/W)
	measured	measured
2000	45.84 (4.58)	22.30 (2.23)

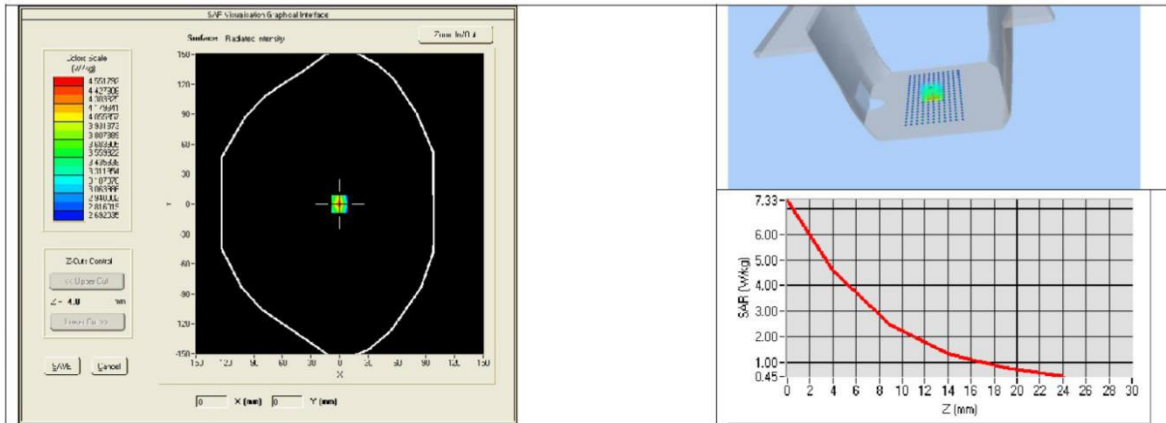

*This document shall not be reproduced, except in full or in part, without the written approval of SATIMO. The information contained herein is to be used only for the purpose for which it is submitted and is not to be released in whole or part without written approval of SATIMO.*



## SAR REFERENCE DIPOLE CALIBRATION REPORT

Ref: ACR.287.7.14.SATU.A

## 8 LIST OF EQUIPMENT

Equipment Summary Sheet				
Equipment Description	Manufacturer / Model	Identification No.	Current Calibration Date	Next Calibration Date
SAM Phantom	Satimo	SN-20/09-SAM71	Validated. No cal required.	Validated. No cal required.
COMOSAR Test Bench	Version 3	NA	Validated. No cal required.	Validated. No cal required.
Network Analyzer	Rhode & Schwarz ZVA	SN100132	02/2016	02/2019
Calipers	Carrera	CALIPER-01	12/2016	12/2019
Reference Probe	Satimo	EPG122 SN 18/11	10/2018	10/2019
Multimeter	Keithley 2000	1188656	12/2016	12/2019
Signal Generator	Agilent E4438C	MY49070581	12/2016	12/2019
Amplifier	Aethercomm	SN 046	Characterized prior to test. No cal required.	Characterized prior to test. No cal required.
Power Meter	HP E4418A	US38261498	12/2016	12/2019
Power Sensor	HP ECP-E26A	US37181460	12/2016	12/2019
Directional Coupler	Narda 4216-20	01386	Characterized prior to test. No cal required.	Characterized prior to test. No cal required.
Temperature and Humidity Sensor	Control Company	11-661-9	8/2016	8/2019

Page: 11/11

*This document shall not be reproduced, except in full or in part, without the written approval of SATIMO. The information contained herein is to be used only for the purpose for which it is submitted and is not to be released in whole or part without written approval of SATIMO.*

## 5.5 SID2450 Dipole Calibration Certificate



### SAR Reference Dipole Calibration Report

Ref : ACR.287.8.14.SATU.A

**SHENZHEN LCS COMPLIANCE TESTING  
LABORATORY LTD.**

**1F., XINGYUAN INDUSTRIAL PARK, TONGDA ROAD,  
BAO'AN BLVD**

**BAO'AN DISTRICT, SHENZHEN, GUANGDONG, CHINA**

**SATIMO COMOSAR REFERENCE DIPOLE**

**FREQUENCY: 2450 MHZ**

**SERIAL NO.: SN 07/14 DIP 2G450-306**

**Calibrated at SATIMO US**

**2105 Barrett Park Dr. - Kennesaw, GA 30144**



**10/01/2018**

*Summary:*

This document presents the method and results from an accredited SAR reference dipole calibration performed in SATIMO USA using the COMOSAR test bench. All calibration results are traceable to national metrology institutions.



## SAR REFERENCE DIPOLE CALIBRATION REPORT

Ref: ACR.287.8.14.SATU.A

	<i>Name</i>	<i>Function</i>	<i>Date</i>	<i>Signature</i>
<i>Prepared by :</i>	Jérôme LUC	Product Manager	10/14/2018	<i>JS</i>
<i>Checked by :</i>	Jérôme LUC	Product Manager	10/14/2018	<i>JS</i>
<i>Approved by :</i>	Kim RUTKOWSKI	Quality Manager	10/14/2018	<i>Kim Rutkowski</i>

	<i>Customer Name</i>
<i>Distribution :</i>	Shenzhen LCS Compliance Testing Laboratory Ltd.

<i>Issue</i>	<i>Date</i>	<i>Modifications</i>
A	10/14/2018	Initial release

Page: 2/11

*This document shall not be reproduced, except in full or in part, without the written approval of SATIMO.  
The information contained herein is to be used only for the purpose for which it is submitted and is not to  
be released in whole or part without written approval of SATIMO.*



## TABLE OF CONTENTS

1	Introduction.....	4
2	Device Under Test .....	4
3	Product Description .....	4
3.1	General Information .....	4
4	Measurement Method .....	5
4.1	Return Loss Requirements .....	5
4.2	Mechanical Requirements .....	5
5	Measurement Uncertainty .....	5
5.1	Return Loss .....	5
5.2	Dimension Measurement .....	5
5.3	Validation Measurement .....	5
6	Calibration Measurement Results .....	6
6.1	Return Loss and Impedance .....	6
6.2	Mechanical Dimensions .....	6
7	Validation measurement .....	7
7.1	Head Liquid Measurement .....	7
7.2	SAR Measurement Result With Head Liquid .....	7
7.3	Body Liquid Measurement .....	9
7.4	SAR Measurement Result With Body Liquid .....	9
8	List of Equipment .....	11





## 1 INTRODUCTION

This document contains a summary of the requirements set forth by the IEEE 1528, OET 65 Bulletin C and CEI/IEC 62209 standards for reference dipoles used for SAR measurement system validations and the measurements that were performed to verify that the product complies with the fore mentioned standards.

## 2 DEVICE UNDER TEST

Device Under Test	
Device Type	COMOSAR 2450 MHz REFERENCE DIPOLE
Manufacturer	Satimo
Model	SID2450
Serial Number	SN 07/14 DIP 2G450-306
Product Condition (new / used)	New

A yearly calibration interval is recommended.

## 3 PRODUCT DESCRIPTION

### 3.1 GENERAL INFORMATION

Satimo's COMOSAR Validation Dipoles are built in accordance to the IEEE 1528, OET 65 Bulletin C and CEI/IEC 62209 standards. The product is designed for use with the COMOSAR test bench only.



**Figure 1** – Satimo COMOSAR Validation Dipole

Page: 4/11

*This document shall not be reproduced, except in full or in part, without the written approval of SATIMO. The information contained herein is to be used only for the purpose for which it is submitted and is not to be released in whole or part without written approval of SATIMO.*



#### 4 MEASUREMENT METHOD

The IEEE 1528, OET 65 Bulletin C and CEI/IEC 62209 standards provide requirements for reference dipoles used for system validation measurements. The following measurements were performed to verify that the product complies with the fore mentioned standards.

##### 4.1 RETURN LOSS REQUIREMENTS

The dipole used for SAR system validation measurements and checks must have a return loss of -20 dB or better. The return loss measurement shall be performed against a liquid filled flat phantom, with the phantom constructed as outlined in the fore mentioned standards.

##### 4.2 MECHANICAL REQUIREMENTS

The IEEE Std. 1528 and CEI/IEC 62209 standards specify the mechanical components and dimensions of the validation dipoles, with the dimensions frequency and phantom shell thickness dependent. The COMOSAR test bench employs a 2 mm phantom shell thickness therefore the dipoles sold for use with the COMOSAR test bench comply with the requirements set forth for a 2 mm phantom shell thickness.

#### 5 MEASUREMENT UNCERTAINTY

All uncertainties listed below represent an expanded uncertainty expressed at approximately the 95% confidence level using a coverage factor of  $k=2$ , traceable to the Internationally Accepted Guides to Measurement Uncertainty.

##### 5.1 RETURN LOSS

The following uncertainties apply to the return loss measurement:

Frequency band	Expanded Uncertainty on Return Loss
400-6000MHz	0.1 dB

##### 5.2 DIMENSION MEASUREMENT

The following uncertainties apply to the dimension measurements:

Length (mm)	Expanded Uncertainty on Length
3 - 300	0.05 mm

##### 5.3 VALIDATION MEASUREMENT

The guidelines outlined in the IEEE 1528, OET 65 Bulletin C, CENELEC EN50361 and CEI/IEC 62209 standards were followed to generate the measurement uncertainty for validation measurements.

Scan Volume	Expanded Uncertainty
1 g	20.3 %
10 g	20.1 %

Page: 5/11

*This document shall not be reproduced, except in full or in part, without the written approval of SATIMO. The information contained herein is to be used only for the purpose for which it is submitted and is not to be released in whole or part without written approval of SATIMO.*



## SAR REFERENCE DIPOLE CALIBRATION REPORT

Ref: ACR.287.8.14.SATU.A

## 6 CALIBRATION MEASUREMENT RESULTS

### 6.1 RETURN LOSS AND IMPEDANCE

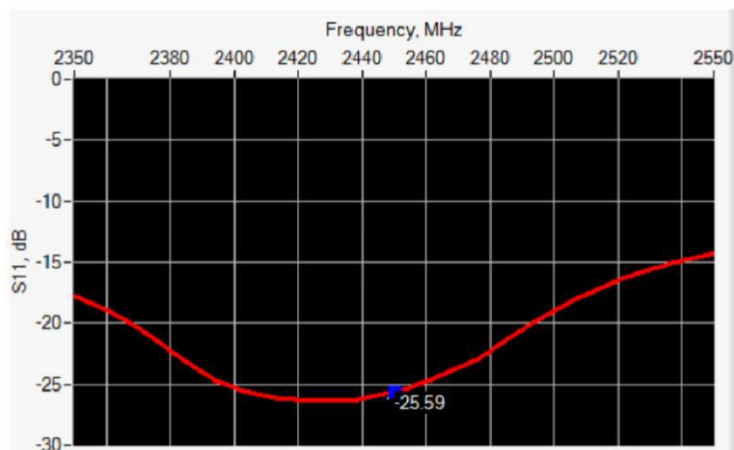

Frequency (MHz)	Return Loss (dB)	Requirement (dB)	Impedance
2450	-25.59	-20	44.7 $\Omega$ - 1.1 j $\Omega$

### 6.2 MECHANICAL DIMENSIONS

Frequency MHz	L mm		h mm		d mm	
	required	measured	required	measured	required	measured
300	420.0 $\pm$ 1 %.		250.0 $\pm$ 1 %.		6.35 $\pm$ 1 %.	
450	290.0 $\pm$ 1 %.		166.7 $\pm$ 1 %.		6.35 $\pm$ 1 %.	
750	176.0 $\pm$ 1 %.		100.0 $\pm$ 1 %.		6.35 $\pm$ 1 %.	
835	161.0 $\pm$ 1 %.		89.8 $\pm$ 1 %.		3.6 $\pm$ 1 %.	
900	149.0 $\pm$ 1 %.		83.3 $\pm$ 1 %.		3.6 $\pm$ 1 %.	
1450	89.1 $\pm$ 1 %.		51.7 $\pm$ 1 %.		3.6 $\pm$ 1 %.	
1500	80.5 $\pm$ 1 %.		50.0 $\pm$ 1 %.		3.6 $\pm$ 1 %.	
1640	79.0 $\pm$ 1 %.		45.7 $\pm$ 1 %.		3.6 $\pm$ 1 %.	
1750	75.2 $\pm$ 1 %.		42.9 $\pm$ 1 %.		3.6 $\pm$ 1 %.	
1800	72.0 $\pm$ 1 %.		41.7 $\pm$ 1 %.		3.6 $\pm$ 1 %.	
1900	68.0 $\pm$ 1 %.		39.5 $\pm$ 1 %.		3.6 $\pm$ 1 %.	
1950	66.3 $\pm$ 1 %.		38.5 $\pm$ 1 %.		3.6 $\pm$ 1 %.	
2000	64.5 $\pm$ 1 %.		37.5 $\pm$ 1 %.		3.6 $\pm$ 1 %.	
2100	61.0 $\pm$ 1 %.		35.7 $\pm$ 1 %.		3.6 $\pm$ 1 %.	
2300	55.5 $\pm$ 1 %.		32.6 $\pm$ 1 %.		3.6 $\pm$ 1 %.	
2450	51.5 $\pm$ 1 %.	PASS	30.4 $\pm$ 1 %.	PASS	3.6 $\pm$ 1 %.	PASS
2600	48.5 $\pm$ 1 %.		28.8 $\pm$ 1 %.		3.6 $\pm$ 1 %.	
3000	41.5 $\pm$ 1 %.		25.0 $\pm$ 1 %.		3.6 $\pm$ 1 %.	
3500	37.0 $\pm$ 1 %.		26.4 $\pm$ 1 %.		3.6 $\pm$ 1 %.	
3700	34.7 $\pm$ 1 %.		26.4 $\pm$ 1 %.		3.6 $\pm$ 1 %.	

Page: 6/11

*This document shall not be reproduced, except in full or in part, without the written approval of SATIMO. The information contained herein is to be used only for the purpose for which it is submitted and is not to be released in whole or part without written approval of SATIMO.*



## 7 VALIDATION MEASUREMENT

The IEEE Std. 1528, OET 65 Bulletin C and CEI/IEC 62209 standards state that the system validation measurements must be performed using a reference dipole meeting the fore mentioned return loss and mechanical dimension requirements. The validation measurement must be performed against a liquid filled flat phantom, with the phantom constructed as outlined in the fore mentioned standards. Per the standards, the dipole shall be positioned below the bottom of the phantom, with the dipole length centered and parallel to the longest dimension of the flat phantom, with the top surface of the dipole at the described distance from the bottom surface of the phantom.

### 7.1 HEAD LIQUID MEASUREMENT

Frequency MHz	Relative permittivity ( $\epsilon_r'$ )		Conductivity ( $\sigma$ ) S/m	
	required	measured	required	measured
300	45.3 $\pm$ 5 %		0.87 $\pm$ 5 %	
450	43.5 $\pm$ 5 %		0.87 $\pm$ 5 %	
750	41.9 $\pm$ 5 %		0.89 $\pm$ 5 %	
835	41.5 $\pm$ 5 %		0.90 $\pm$ 5 %	
900	41.5 $\pm$ 5 %		0.97 $\pm$ 5 %	
1450	40.5 $\pm$ 5 %		1.20 $\pm$ 5 %	
1500	40.4 $\pm$ 5 %		1.23 $\pm$ 5 %	
1640	40.2 $\pm$ 5 %		1.31 $\pm$ 5 %	
1750	40.1 $\pm$ 5 %		1.37 $\pm$ 5 %	
1800	40.0 $\pm$ 5 %		1.40 $\pm$ 5 %	
1900	40.0 $\pm$ 5 %		1.40 $\pm$ 5 %	
1950	40.0 $\pm$ 5 %		1.40 $\pm$ 5 %	
2000	40.0 $\pm$ 5 %		1.40 $\pm$ 5 %	
2100	39.8 $\pm$ 5 %		1.49 $\pm$ 5 %	
2300	39.5 $\pm$ 5 %		1.67 $\pm$ 5 %	
2450	39.2 $\pm$ 5 %	PASS	1.80 $\pm$ 5 %	PASS
2600	39.0 $\pm$ 5 %		1.96 $\pm$ 5 %	
3000	38.5 $\pm$ 5 %		2.40 $\pm$ 5 %	
3500	37.9 $\pm$ 5 %		2.91 $\pm$ 5 %	

### 7.2 SAR MEASUREMENT RESULT WITH HEAD LIQUID

The IEEE Std. 1528 and CEI/IEC 62209 standards state that the system validation measurements should produce the SAR values shown below (for phantom thickness of 2 mm), within the uncertainty for the system validation. All SAR values are normalized to 1 W forward power. In bracket, the measured SAR is given with the used input power.

Software	OPENSAR V4
Phantom	SN 20/09 SAM71
Probe	SN 18/11 EPG122
Liquid	Head Liquid Values: $\epsilon_r'$ : 39.0 sigma : 1.77
Distance between dipole center and liquid	10.0 mm
Area scan resolution	dx=8mm/dy=8mm

Page: 7/11

*This document shall not be reproduced, except in full or in part, without the written approval of SATIMO.  
The information contained herein is to be used only for the purpose for which it is submitted and is not to be released in whole or part without written approval of SATIMO.*



SAR REFERENCE DIPOLE CALIBRATION REPORT

Ref: ACR.287.8.14.SATU.A

Zoon Scan Resolution	dx=8mm/dy=8m/dz=5mm
Frequency	2450 MHz
Input power	20 dBm
Liquid Temperature	21 °C
Lab Temperature	21 °C
Lab Humidity	45 %

Frequency MHz	1 g SAR (W/kg/W)		10 g SAR (W/kg/W)	
	required	measured	required	measured
300	2.85		1.94	
450	4.58		3.06	
750	8.49		5.55	
835	9.56		6.22	
900	10.9		6.99	
1450	29		16	
1500	30.5		16.8	
1640	34.2		18.4	
1750	36.4		19.3	
1800	38.4		20.1	
1900	39.7		20.5	
1950	40.5		20.9	
2000	41.1		21.1	
2100	43.6		21.9	
2300	48.7		23.3	
2450	52.4	53.89 (5.39)	24	24.15 (2.42)
2600	55.3		24.6	
3000	63.8		25.7	
3500	67.1		25	

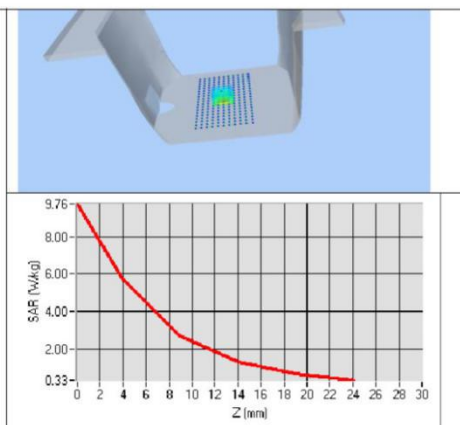
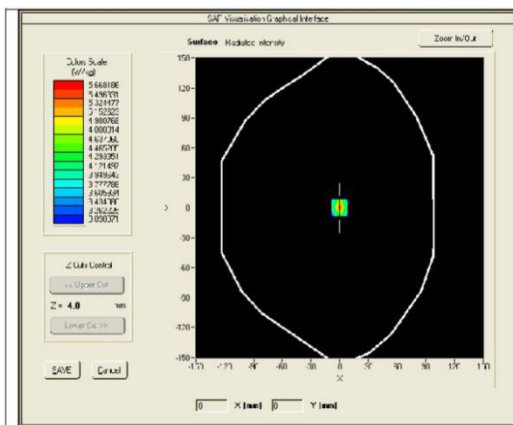

*This document shall not be reproduced, except in full or in part, without the written approval of SATIMO. The information contained herein is to be used only for the purpose for which it is submitted and is not to be released in whole or part without written approval of SATIMO.*



## SAR REFERENCE DIPOLE CALIBRATION REPORT

Ref: ACR.287.8.14.SATU.A

## 7.3 BODY LIQUID MEASUREMENT

Frequency MHz	Relative permittivity ( $\epsilon_r'$ )		Conductivity ( $\sigma$ ) S/m	
	required	measured	required	measured
150	61.9 $\pm$ 5 %		0.80 $\pm$ 5 %	
300	58.2 $\pm$ 5 %		0.92 $\pm$ 5 %	
450	56.7 $\pm$ 5 %		0.94 $\pm$ 5 %	
750	55.5 $\pm$ 5 %		0.96 $\pm$ 5 %	
835	55.2 $\pm$ 5 %		0.97 $\pm$ 5 %	
900	55.0 $\pm$ 5 %		1.05 $\pm$ 5 %	
915	55.0 $\pm$ 5 %		1.06 $\pm$ 5 %	
1450	54.0 $\pm$ 5 %		1.30 $\pm$ 5 %	
1610	53.8 $\pm$ 5 %		1.40 $\pm$ 5 %	
1800	53.3 $\pm$ 5 %		1.52 $\pm$ 5 %	
1900	53.3 $\pm$ 5 %		1.52 $\pm$ 5 %	
2000	53.3 $\pm$ 5 %		1.52 $\pm$ 5 %	
2100	53.2 $\pm$ 5 %		1.62 $\pm$ 5 %	
2450	52.7 $\pm$ 5 %	PASS	1.95 $\pm$ 5 %	PASS
2600	52.5 $\pm$ 5 %		2.16 $\pm$ 5 %	
3000	52.0 $\pm$ 5 %		2.73 $\pm$ 5 %	
3500	51.3 $\pm$ 5 %		3.31 $\pm$ 5 %	
5200	49.0 $\pm$ 10 %		5.30 $\pm$ 10 %	
5300	48.9 $\pm$ 10 %		5.42 $\pm$ 10 %	
5400	48.7 $\pm$ 10 %		5.53 $\pm$ 10 %	
5500	48.6 $\pm$ 10 %		5.65 $\pm$ 10 %	
5600	48.5 $\pm$ 10 %		5.77 $\pm$ 10 %	
5800	48.2 $\pm$ 10 %		6.00 $\pm$ 10 %	

## 7.4 SAR MEASUREMENT RESULT WITH BODY LIQUID

Software	OPENSAR V4
Phantom	SN 20/09 SAM71
Probe	SN 18/11 EPG122
Liquid	Body Liquid Values: $\epsilon_r'$ : 53.0 sigma : 1.93
Distance between dipole center and liquid	10.0 mm
Area scan resolution	dx=8mm/dy=8mm
Zoon Scan Resolution	dx=8mm/dy=8m/dz=5mm
Frequency	2450 MHz
Input power	20 dBm
Liquid Temperature	21 °C
Lab Temperature	21 °C
Lab Humidity	45 %

Page: 9/11

*This document shall not be reproduced, except in full or in part, without the written approval of SATIMO.  
The information contained herein is to be used only for the purpose for which it is submitted and is not to be released in whole or part without written approval of SATIMO.*



SAR REFERENCE DIPOLE CALIBRATION REPORT

Ref: ACR.287.8.14.SATU.A

Frequency MHz	1 g SAR (W/kg/W)	10 g SAR (W/kg/W)
	measured	measured
2450	54.65 (5.46)	24.58 (2.46)

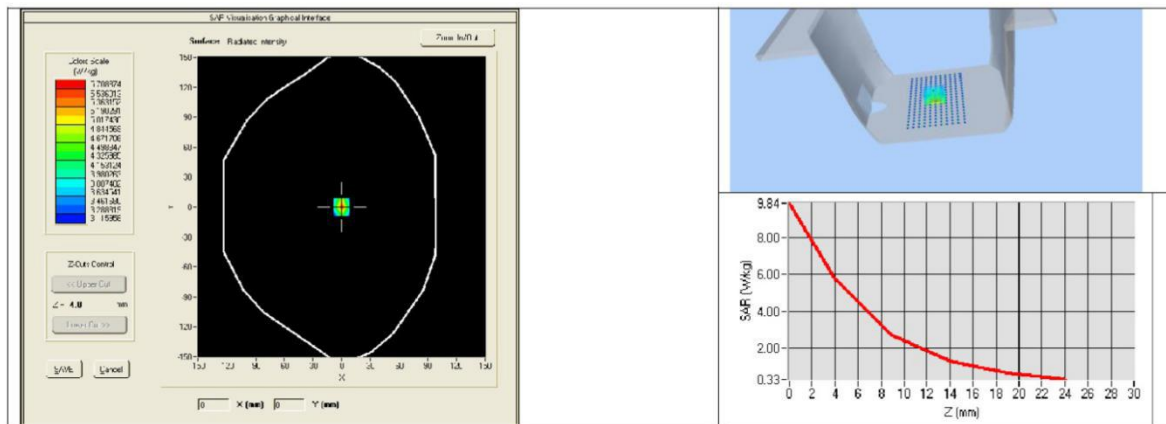

*This document shall not be reproduced, except in full or in part, without the written approval of SATIMO. The information contained herein is to be used only for the purpose for which it is submitted and is not to be released in whole or part without written approval of SATIMO.*



## SAR REFERENCE DIPOLE CALIBRATION REPORT

Ref: ACR.287.8.14.SATU.A

## 8 LIST OF EQUIPMENT

Equipment Summary Sheet				
Equipment Description	Manufacturer / Model	Identification No.	Current Calibration Date	Next Calibration Date
SAM Phantom	Satimo	SN-20/09-SAM71	Validated. No cal required.	Validated. No cal required.
COMOSAR Test Bench	Version 3	NA	Validated. No cal required.	Validated. No cal required.
Network Analyzer	Rhode & Schwarz ZVA	SN100132	02/2016	02/2019
Calipers	Carrera	CALIPER-01	12/2016	12/2019
Reference Probe	Satimo	EPG122 SN 18/11	10/2018	10/2019
Multimeter	Keithley 2000	1188656	12/2016	12/2019
Signal Generator	Agilent E4438C	MY49070581	12/2016	12/2019
Amplifier	Aethercomm	SN 046	Characterized prior to test. No cal required.	Characterized prior to test. No cal required.
Power Meter	HP E4418A	US38261498	12/2016	12/2019
Power Sensor	HP ECP-E26A	US37181460	12/2016	12/2019
Directional Coupler	Narda 4216-20	01386	Characterized prior to test. No cal required.	Characterized prior to test. No cal required.
Temperature and Humidity Sensor	Control Company	11-661-9	8/2016	8/2019

Page: 11/11

*This document shall not be reproduced, except in full or in part, without the written approval of SATIMO.  
The information contained herein is to be used only for the purpose for which it is submitted and is not to be released in whole or part without written approval of SATIMO.*



## 5.6 SID2600 Dipole Calibration Certificate



### SAR Reference Dipole Calibration Report

Ref : ACR.273.4.18.SATU.A

**SHENZHEN LCS COMPLIANCE TESTING  
LABORATORY LTD.**

**1F., XINGYUAN INDUSTRIAL PARK, TONGDA ROAD,  
BAO'AN BLVD  
BAO'AN DISTRICT, SHENZHEN, GUANGDONG, CHINA  
MVG COMOSAR REFERENCE DIPOLE**

**FREQUENCY: 2600 MHZ  
SERIAL NO.: SN 38/18 DIP 2G600-468**

**Calibrated at MVG US  
2105 Barrett Park Dr. - Kennesaw, GA 30144**



**Calibration Date: 09/24/2018**

*Summary:*

This document presents the method and results from an accredited SAR reference dipole calibration performed in MVG USA using the COMOSAR test bench. All calibration results are traceable to national metrology institutions.



SAR REFERENCE DIPOLE CALIBRATION REPORT

Ref: ACR.273.4.18.SATU.A

	Name	Function	Date	Signature
Prepared by :	Jérôme LUC	Product Manager	09/30/2018	<i>JS</i>
Checked by :	Jérôme LUC	Product Manager	09/30/2018	<i>JS</i>
Approved by :	Kim RUTKOWSKI	Quality Manager	09/30/2018	<i>Kim Rutkowski</i>

	Customer Name
Distribution :	Shenzhen LCS Compliance Testing Laboratory Ltd.

Issue	Date	Modifications
A	09/30/2018	Initial release

*This document shall not be reproduced, except in full or in part, without the written approval of MVG. The information contained herein is to be used only for the purpose for which it is submitted and is not to be released in whole or part without written approval of MVG.*



## SAR REFERENCE DIPOLE CALIBRATION REPORT

Ref: ACR.273.4.18.SATU.A

## TABLE OF CONTENTS

1	Introduction.....	4
2	Device Under Test .....	4
3	Product Description .....	4
3.1	General Information .....	4
4	Measurement Method .....	5
4.1	Return Loss Requirements .....	5
4.2	Mechanical Requirements .....	5
5	Measurement Uncertainty.....	5
5.1	Return Loss .....	5
5.2	Dimension Measurement .....	5
5.3	Validation Measurement .....	5
6	Calibration Measurement Results.....	6
6.1	Return Loss and Impedance In Head Liquid .....	6
6.2	Return Loss and Impedance In Body Liquid .....	6
6.3	Mechanical Dimensions .....	6
7	Validation measurement .....	7
7.1	Head Liquid Measurement .....	7
7.2	SAR Measurement Result With Head Liquid .....	8
7.3	Body Liquid Measurement .....	9
7.4	SAR Measurement Result With Body Liquid .....	10
8	List of Equipment .....	11

Page: 3/11

*This document shall not be reproduced, except in full or in part, without the written approval of MVG.  
The information contained herein is to be used only for the purpose for which it is submitted and is not to be released in whole or part without written approval of MVG.*



## SAR REFERENCE DIPOLE CALIBRATION REPORT

Ref: ACR.273.4.18.SATU.A

## 1 INTRODUCTION

This document contains a summary of the requirements set forth by the IEEE 1528, FCC KDBs and CEI/IEC 62209 standards for reference dipoles used for SAR measurement system validations and the measurements that were performed to verify that the product complies with the fore mentioned standards.

## 2 DEVICE UNDER TEST

Device Under Test	
Device Type	COMOSAR 2600 MHz REFERENCE DIPOLE
Manufacturer	MVG
Model	SID2600
Serial Number	SN 38/18 DIP 2G600-468
Product Condition (new / used)	Used

A yearly calibration interval is recommended.

## 3 PRODUCT DESCRIPTION

### 3.1 GENERAL INFORMATION

MVG's COMOSAR Validation Dipoles are built in accordance to the IEEE 1528, FCC KDBs and CEI/IEC 62209 standards. The product is designed for use with the COMOSAR test bench only.



**Figure 1** – MVG COMOSAR Validation Dipole

Page: 4/11

*This document shall not be reproduced, except in full or in part, without the written approval of MVG.  
The information contained herein is to be used only for the purpose for which it is submitted and is not to be released in whole or part without written approval of MVG.*



SAR REFERENCE DIPOLE CALIBRATION REPORT

Ref: ACR.273.4.18.SATU.A

10 g	20.1 %
------	--------

6 CALIBRATION MEASUREMENT RESULTS

6.1 RETURN LOSS AND IMPEDANCE IN HEAD LIQUID

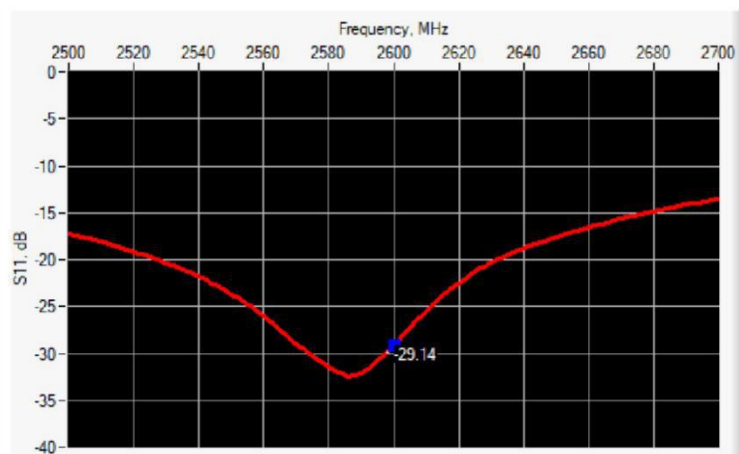

Frequency (MHz)	Return Loss (dB)	Requirement (dB)	Impedance
2600	-29.14	-20	49.2 Ω + 3.4 jΩ

6.2 RETURN LOSS AND IMPEDANCE IN BODY LIQUID

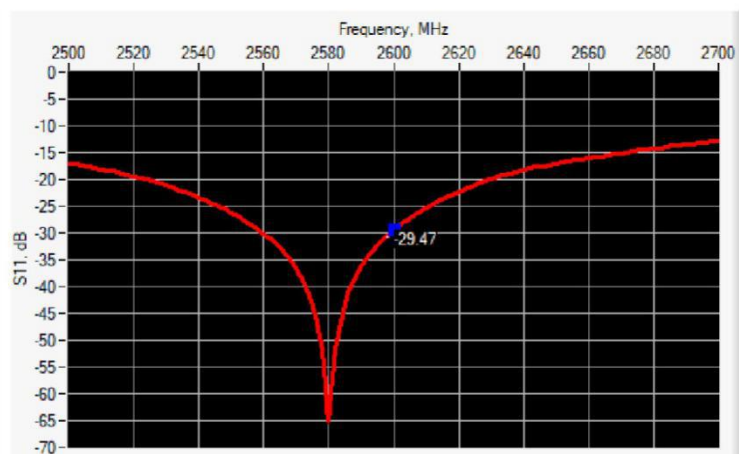

Frequency (MHz)	Return Loss (dB)	Requirement (dB)	Impedance
2600	-29.47	-20	47.5 Ω + 2.2 jΩ

6.3 MECHANICAL DIMENSIONS

Frequency MHz	L mm		h mm		d mm	
	required	measured	required	measured	required	measured
300	420.0 ±1 %.		250.0 ±1 %.		6.35 ±1 %.	

*This document shall not be reproduced, except in full or in part, without the written approval of MVG. The information contained herein is to be used only for the purpose for which it is submitted and is not to be released in whole or part without written approval of MVG.*



## SAR REFERENCE DIPOLE CALIBRATION REPORT

Ref: ACR.273.4.18.SATU.A

450	290.0 ±1 %.		166.7 ±1 %.		6.35 ±1 %.	
750	176.0 ±1 %.		100.0 ±1 %.		6.35 ±1 %.	
835	161.0 ±1 %.		89.8 ±1 %.		3.6 ±1 %.	
900	149.0 ±1 %.		83.3 ±1 %.		3.6 ±1 %.	
1450	89.1 ±1 %.		51.7 ±1 %.		3.6 ±1 %.	
1500	80.5 ±1 %.		50.0 ±1 %.		3.6 ±1 %.	
1640	79.0 ±1 %.		45.7 ±1 %.		3.6 ±1 %.	
1750	75.2 ±1 %.		42.9 ±1 %.		3.6 ±1 %.	
1800	72.0 ±1 %.		41.7 ±1 %.		3.6 ±1 %.	
1900	68.0 ±1 %.		39.5 ±1 %.		3.6 ±1 %.	
1950	66.3 ±1 %.		38.5 ±1 %.		3.6 ±1 %.	
2000	64.5 ±1 %.		37.5 ±1 %.		3.6 ±1 %.	
2100	61.0 ±1 %.		35.7 ±1 %.		3.6 ±1 %.	
2300	55.5 ±1 %.		32.6 ±1 %.		3.6 ±1 %.	
2450	51.5 ±1 %.		30.4 ±1 %.		3.6 ±1 %.	
2600	48.5 ±1 %.	PASS	28.8 ±1 %.	PASS	3.6 ±1 %.	PASS
3000	41.5 ±1 %.		25.0 ±1 %.		3.6 ±1 %.	
3500	37.0 ±1 %.		26.4 ±1 %.		3.6 ±1 %.	
3700	34.7 ±1 %.		26.4 ±1 %.		3.6 ±1 %.	

## 7 VALIDATION MEASUREMENT

The IEEE Std. 1528, FCC KDBs and CEI/IEC 62209 standards state that the system validation measurements must be performed using a reference dipole meeting the fore mentioned return loss and mechanical dimension requirements. The validation measurement must be performed against a liquid filled flat phantom, with the phantom constructed as outlined in the fore mentioned standards. Per the standards, the dipole shall be positioned below the bottom of the phantom, with the dipole length centered and parallel to the longest dimension of the flat phantom, with the top surface of the dipole at the described distance from the bottom surface of the phantom.

### 7.1 HEAD LIQUID MEASUREMENT

Frequency MHz	Relative permittivity ( $\epsilon_r'$ )		Conductivity ( $\sigma$ ) S/m	
	required	measured	required	measured
300	45.3 ±5 %		0.87 ±5 %	
450	43.5 ±5 %		0.87 ±5 %	
750	41.9 ±5 %		0.89 ±5 %	
835	41.5 ±5 %		0.90 ±5 %	
900	41.5 ±5 %		0.97 ±5 %	
1450	40.5 ±5 %		1.20 ±5 %	
1500	40.4 ±5 %		1.23 ±5 %	
1640	40.2 ±5 %		1.31 ±5 %	
1750	40.1 ±5 %		1.37 ±5 %	

Page: 7/11

*This document shall not be reproduced, except in full or in part, without the written approval of MVG.  
The information contained herein is to be used only for the purpose for which it is submitted and is not to be released in whole or part without written approval of MVG.*



## SAR REFERENCE DIPOLE CALIBRATION REPORT

Ref: ACR.273.4.18.SATU.A

1800	40.0 ±5 %		1.40 ±5 %	
1900	40.0 ±5 %		1.40 ±5 %	
1950	40.0 ±5 %		1.40 ±5 %	
2000	40.0 ±5 %		1.40 ±5 %	
2100	39.8 ±5 %		1.49 ±5 %	
2300	39.5 ±5 %		1.67 ±5 %	
2450	39.2 ±5 %		1.80 ±5 %	
2600	39.0 ±5 %	PASS	1.96 ±5 %	PASS
3000	38.5 ±5 %		2.40 ±5 %	
3500	37.9 ±5 %		2.91 ±5 %	

## 7.2 SAR MEASUREMENT RESULT WITH HEAD LIQUID

The IEEE Std. 1528 and CEI/IEC 62209 standards state that the system validation measurements should produce the SAR values shown below (for phantom thickness of 2 mm), within the uncertainty for the system validation. All SAR values are normalized to 1 W forward power. In bracket, the measured SAR is given with the used input power.

Software	OPENSAR V4
Phantom	SN 20/09 SAM71
Probe	SN 18/11 EPG122
Liquid	Head Liquid Values: eps' : 39.8 sigma : 1.99
Distance between dipole center and liquid	10.0 mm
Area scan resolution	dx=8mm/dy=8mm
Zoon Scan Resolution	dx=5mm/dy=5mm/dz=5mm
Frequency	2600 MHz
Input power	20 dBm
Liquid Temperature	21 °C
Lab Temperature	21 °C
Lab Humidity	45 %

Frequency MHz	1 g SAR (W/kg/W)		10 g SAR (W/kg/W)	
	required	measured	required	measured
300	2.85		1.94	
450	4.58		3.06	
750	8.49		5.55	
835	9.56		6.22	
900	10.9		6.99	
1450	29		16	
1500	30.5		16.8	
1640	34.2		18.4	
1750	36.4		19.3	
1800	38.4		20.1	

Page: 8/11

*This document shall not be reproduced, except in full or in part, without the written approval of MVG.  
The information contained herein is to be used only for the purpose for which it is submitted and is not to be released in whole or part without written approval of MVG.*



SAR REFERENCE DIPOLE CALIBRATION REPORT

Ref: ACR.273.4.18.SATU.A

1900	39.7		20.5	
1950	40.5		20.9	
2000	41.1		21.1	
2100	43.6		21.9	
2300	48.7		23.3	
2450	52.4		24	
2600	55.3	56.91 (5.69)	24.6	24.69 (2.47)
3000	63.8		25.7	
3500	67.1		25	
3700	67.4		24.2	

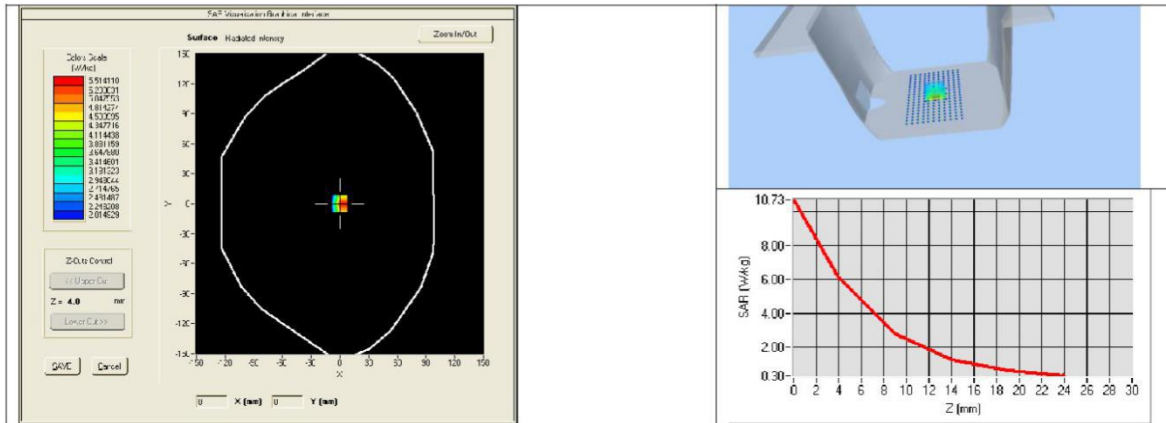

7.3 BODY LIQUID MEASUREMENT

Frequency MHz	Relative permittivity ( $\epsilon_r'$ )		Conductivity ( $\sigma$ ) S/m	
	required	measured	required	measured
150	61.9 ±5 %		0.80 ±5 %	
300	58.2 ±5 %		0.92 ±5 %	
450	56.7 ±5 %		0.94 ±5 %	
750	55.5 ±5 %		0.96 ±5 %	
835	55.2 ±5 %		0.97 ±5 %	
900	55.0 ±5 %		1.05 ±5 %	
915	55.0 ±5 %		1.06 ±5 %	
1450	54.0 ±5 %		1.30 ±5 %	
1610	53.8 ±5 %		1.40 ±5 %	
1800	53.3 ±5 %		1.52 ±5 %	
1900	53.3 ±5 %		1.52 ±5 %	
2000	53.3 ±5 %		1.52 ±5 %	
2100	53.2 ±5 %		1.62 ±5 %	

This document shall not be reproduced, except in full or in part, without the written approval of MVG. The information contained herein is to be used only for the purpose for which it is submitted and is not to be released in whole or part without written approval of MVG.





SAR REFERENCE DIPOLE CALIBRATION REPORT

Ref: ACR.273.4.18.SATU.A

2300	52.9 ±5 %		1.81 ±5 %	
2450	52.7 ±5 %		1.95 ±5 %	
2600	52.5 ±5 %	PASS	2.16 ±5 %	PASS
3000	52.0 ±5 %		2.73 ±5 %	
3500	51.3 ±5 %		3.31 ±5 %	
3700	51.0 ±5 %		3.55 ±5 %	
5200	49.0 ±10 %		5.30 ±10 %	
5300	48.9 ±10 %		5.42 ±10 %	
5400	48.7 ±10 %		5.53 ±10 %	
5500	48.6 ±10 %		5.65 ±10 %	
5600	48.5 ±10 %		5.77 ±10 %	
5800	48.2 ±10 %		6.00 ±10 %	

7.4 SAR MEASUREMENT RESULT WITH BODY LIQUID

Software	OPENSAR V4
Phantom	SN 20/09 SAM71
Probe	SN 18/11 EPG122
Liquid	Body Liquid Values: eps' : 52.5 sigma : 2.23
Distance between dipole center and liquid	10.0 mm
Area scan resolution	dx=8mm/dy=8mm
Zoon Scan Resolution	dx=5mm/dy=5mm/dz=5mm
Frequency	2600 MHz
Input power	20 dBm
Liquid Temperature	21 °C
Lab Temperature	21 °C
Lab Humidity	45 %

Frequency MHz	1 g SAR (W/kg/W)	10 g SAR (W/kg/W)
	measured	measured
2600	54.14 (5.41)	24.13 (2.41)

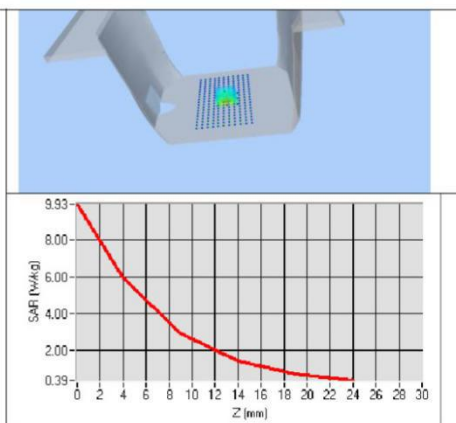
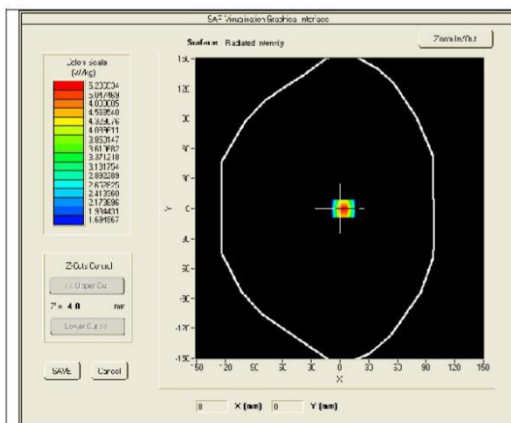

*This document shall not be reproduced, except in full or in part, without the written approval of MVG. The information contained herein is to be used only for the purpose for which it is submitted and is not to be released in whole or part without written approval of MVG.*



## SAR REFERENCE DIPOLE CALIBRATION REPORT

Ref: ACR.273.4.18.SATU.A

## 8 LIST OF EQUIPMENT

Equipment Summary Sheet				
Equipment Description	Manufacturer / Model	Identification No.	Current Calibration Date	Next Calibration Date
SAM Phantom	MVG	SN-20/09-SAM71	Validated. No cal required.	Validated. No cal required.
COMOSAR Test Bench	Version 3	NA	Validated. No cal required.	Validated. No cal required.
Network Analyzer	Rhode & Schwarz ZVA	SN100132	02/2016	02/2019
Calipers	Carrera	CALIPER-01	01/2017	01/2020
Reference Probe	MVG	EPG122 SN 18/11	10/2017	10/2018
Multimeter	Keithley 2000	1188656	01/2017	01/2020
Signal Generator	Agilent E4438C	MY49070581	01/2017	01/2020
Amplifier	Aethercomm	SN 046	Characterized prior to test. No cal required.	Characterized prior to test. No cal required.
Power Meter	HP E4418A	US38261498	01/2017	01/2020
Power Sensor	HP ECP-E26A	US37181460	01/2017	01/2020
Directional Coupler	Narda 4216-20	01386	Characterized prior to test. No cal required.	Characterized prior to test. No cal required.
Temperature and Humidity Sensor	Control Company	150798832	11/2017	11/2020

Page: 11/11

*This document shall not be reproduced, except in full or in part, without the written approval of MVG.  
The information contained herein is to be used only for the purpose for which it is submitted and is not to be released in whole or part without written approval of MVG.*

## 5.7 SID5G-6G Dipole Calibration Certificate



### SAR Reference Waveguide Calibration Report

Ref : ACR.273.5.18.SATU.A

**SHENZHEN LCS COMPLIANCE TESTING  
LABORATORY LTD.**  
**1F., XINGYUAN INDUSTRIAL PARK, TONGDA  
ROAD, BAO'AN BLVD BAO'AN DISTRICT,  
SHENZHEN, GUANGDONG, CHINA**  
**MVG COMOSAR  
REFERENCE WAVEGUIDE**  
**FREQUENCY: 5000-6000 MHZ**  
**SERIAL NO.: SN 49/16 WGA 43**

**Calibrated at MVG US**  
**2105 Barrett Park Dr. - Kennesaw, GA 30144**



**Calibration Date: 09/24/2018**

*Summary:*

This document presents the method and results from an accredited SAR reference waveguide calibration performed in MVG USA using the COMOSAR test bench. All calibration results are traceable to national metrology institutions.



SAR REFERENCE WAVEGUIDE CALIBRATION REPORT

Ref: ACR.273.5.18.SATU.A

	<i>Name</i>	<i>Function</i>	<i>Date</i>	<i>Signature</i>
<i>Prepared by :</i>	Jérôme LUC	Product Manager	09/30/2018	<i>JL</i>
<i>Checked by :</i>	Jérôme LUC	Product Manager	09/30/2018	<i>JL</i>
<i>Approved by :</i>	Kim RUTKOWSKI	Quality Manager	09/30/2018	<i>Kim Rutkowski</i>

	<i>Customer Name</i>
<i>Distribution :</i>	Shenzhen LCS Compliance Testing Laboratory Ltd.

<i>Issue</i>	<i>Date</i>	<i>Modifications</i>
A	09/30/2018	Initial release

*This document shall not be reproduced, except in full or in part, without the written approval of MVG. The information contained herein is to be used only for the purpose for which it is submitted and is not to be released in whole or part without written approval of MVG.*



## SAR REFERENCE WAVEGUIDE CALIBRATION REPORT

Ref: ACR.273.5.18.SATU.A

## TABLE OF CONTENTS

1	Introduction.....	4
2	Device Under Test .....	4
3	Product Description .....	4
3.1	General Information .....	4
4	Measurement Method .....	4
4.1	Return Loss Requirements .....	4
4.2	Mechanical Requirements .....	4
5	Measurement Uncertainty.....	5
5.1	Return Loss .....	5
5.2	Dimension Measurement .....	5
5.3	Validation Measurement .....	5
6	Calibration Measurement Results.....	5
6.1	Return Loss .....	5
6.2	Mechanical Dimensions .....	6
7	Validation measurement .....	7
7.1	Head Liquid Measurement .....	7
7.2	Measurement Result .....	7
7.3	Body Measurement Result .....	10
8	List of Equipment .....	13

Page: 3/13

*This document shall not be reproduced, except in full or in part, without the written approval of MVG.  
The information contained herein is to be used only for the purpose for which it is submitted and is not to be released in whole or part without written approval of MVG.*



## SAR REFERENCE WAVEGUIDE CALIBRATION REPORT

Ref: ACR.273.5.18.SATU.A

## 1 INTRODUCTION

This document contains a summary of the requirements set forth by the IEEE 1528 and CEI/IEC 62209 standards for reference waveguides used for SAR measurement system validations and the measurements that were performed to verify that the product complies with the fore mentioned standards.

## 2 DEVICE UNDER TEST

Device Under Test	
Device Type	COMOSAR 5000-6000 MHz REFERENCE WAVEGUIDE
Manufacturer	MVG
Model	SWG5500
Serial Number	SN 49/16 WGA 43
Product Condition (new / used)	Used

A yearly calibration interval is recommended.

## 3 PRODUCT DESCRIPTION

### 3.1 GENERAL INFORMATION

MVG's COMOSAR Validation Waveguides are built in accordance to the IEEE 1528 and CEI/IEC 62209 standards.

## 4 MEASUREMENT METHOD

The IEEE 1528 and CEI/IEC 62209 standards provide requirements for reference waveguides used for system validation measurements. The following measurements were performed to verify that the product complies with the fore mentioned standards.

### 4.1 RETURN LOSS REQUIREMENTS

The waveguide used for SAR system validation measurements and checks must have a return loss of -8 dB or better. The return loss measurement shall be performed with matching layer placed in the open end of the waveguide, with the waveguide and matching layer in direct contact with the phantom shell as outlined in the fore mentioned standards.

### 4.2 MECHANICAL REQUIREMENTS

The IEEE 1528 and CEI/IEC 62209 standards specify the mechanical dimensions of the validation waveguide, the specified dimensions are as shown in Section 6.2. Figure 1 shows how the dimensions relate to the physical construction of the waveguide.

Page: 4/13

*This document shall not be reproduced, except in full or in part, without the written approval of MVG.  
The information contained herein is to be used only for the purpose for which it is submitted and is not to be released in whole or part without written approval of MVG.*



## SAR REFERENCE WAVEGUIDE CALIBRATION REPORT

Ref: ACR.273.5.18.SATU.A

## 5 MEASUREMENT UNCERTAINTY

All uncertainties listed below represent an expanded uncertainty expressed at approximately the 95% confidence level using a coverage factor of  $k=2$ , traceable to the Internationally Accepted Guides to Measurement Uncertainty.

### 5.1 RETURN LOSS

The following uncertainties apply to the return loss measurement:

Frequency band	Expanded Uncertainty on Return Loss
400-6000MHz	0.1 dB

### 5.2 DIMENSION MEASUREMENT

The following uncertainties apply to the dimension measurements:

Length (mm)	Expanded Uncertainty on Length
3 - 300	0.05 mm

### 5.3 VALIDATION MEASUREMENT

The guidelines outlined in the IEEE 1528 and CEI/IEC 62209 standards were followed to generate the measurement uncertainty for validation measurements.

Scan Volume	Expanded Uncertainty
1 g	20.3 %
10 g	20.1 %

## 6 CALIBRATION MEASUREMENT RESULTS

### 6.1 RETURN LOSS IN HEAD LIQUID

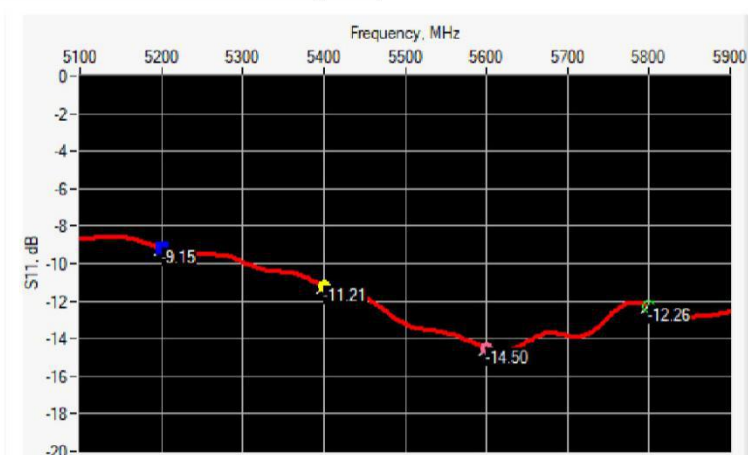

Page: 5/13

*This document shall not be reproduced, except in full or in part, without the written approval of MVG. The information contained herein is to be used only for the purpose for which it is submitted and is not to be released in whole or part without written approval of MVG.*



## SAR REFERENCE WAVEGUIDE CALIBRATION REPORT

Ref: ACR.273.5.18.SATU.A

Frequency (MHz)	Return Loss (dB)	Requirement (dB)	Impedance
5200	-9.15	-8	$20.57 \Omega + 11.55 j\Omega$
5400	-11.21	-8	$75.27 \Omega + 4.08 j\Omega$
5600	-14.50	-8	$33.91 \Omega - 8.72 j\Omega$
5800	-12.26	-8	$53.07 \Omega + 23.41 j\Omega$

## 6.2 RETURN LOSS IN BODY LIQUID

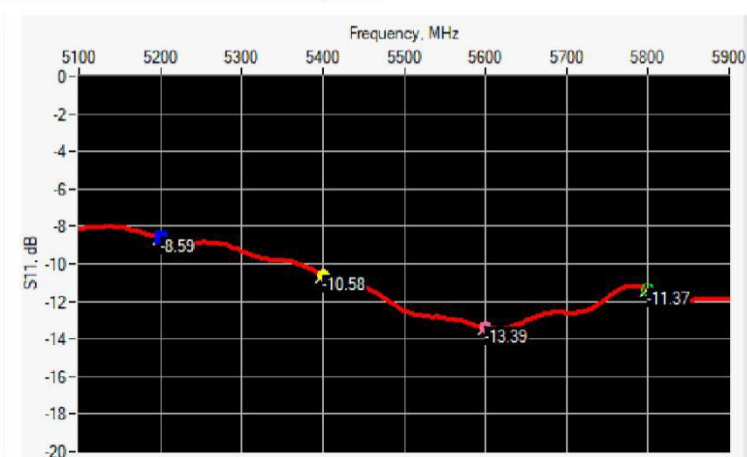

Frequency (MHz)	Return Loss (dB)	Requirement (dB)	Impedance
5200	-8.59	-8	$19.38 \Omega + 13.50 j\Omega$
5400	-10.58	-8	$77.13 \Omega + 1.81 j\Omega$
5600	-13.39	-8	$30.95 \Omega - 7.75 j\Omega$
5800	-11.37	-8	$54.79 \Omega + 25.47 j\Omega$

## 6.3 MECHANICAL DIMENSIONS

Frequency (MHz)	L (mm)		W (mm)		L <sub>r</sub> (mm)		W <sub>r</sub> (mm)		T (mm)	
	Requirement	Measurement	Requirement	Measurement	Requirement	Measurement	Requirement	Measurement	Requirement	Measurement
5200	40.39 ± 0.13	PASS	20.19 ± 0.13	PASS	81.03 ± 0.13	PASS	61.98 ± 0.13	PASS	5.3*	PASS
5800	40.39 ± 0.13	PASS	20.19 ± 0.13	PASS	81.03 ± 0.13	PASS	61.98 ± 0.13	PASS	4.3*	PASS

\* The tolerance for the matching layer is included in the return loss measurement.

Page: 6/13

This document shall not be reproduced, except in full or in part, without the written approval of MVG.  
The information contained herein is to be used only for the purpose for which it is submitted and is not to be released in whole or part without written approval of MVG.





## SAR REFERENCE WAVEGUIDE CALIBRATION REPORT

Ref: ACR.273.5.18.SATU.A

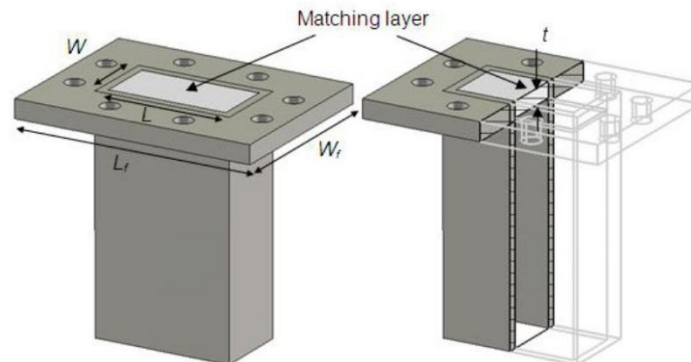

Figure 1: Validation Waveguide Dimensions

## 7 VALIDATION MEASUREMENT

The IEEE Std. 1528 and CEI/IEC 62209 standards state that the system validation measurements must be performed using a reference waveguide meeting the fore mentioned return loss and mechanical dimension requirements. The validation measurement must be performed with the matching layer placed in the open end of the waveguide, with the waveguide and matching layer in direct contact with the phantom shell.

### 7.1 HEAD LIQUID MEASUREMENT

Frequency MHz	Relative permittivity ( $\epsilon_r'$ )		Conductivity ( $\sigma$ ) S/m	
	required	measured	required	measured
5000	36.2 $\pm$ 10 %		4.45 $\pm$ 10 %	
5100	36.1 $\pm$ 10 %		4.56 $\pm$ 10 %	
5200	36.0 $\pm$ 10 %	PASS	4.66 $\pm$ 10 %	PASS
5300	35.9 $\pm$ 10 %		4.76 $\pm$ 10 %	
5400	35.8 $\pm$ 10 %	PASS	4.86 $\pm$ 10 %	PASS
5500	35.6 $\pm$ 10 %		4.97 $\pm$ 10 %	
5600	35.5 $\pm$ 10 %	PASS	5.07 $\pm$ 10 %	PASS
5700	35.4 $\pm$ 10 %		5.17 $\pm$ 10 %	
5800	35.3 $\pm$ 10 %	PASS	5.27 $\pm$ 10 %	PASS
5900	35.2 $\pm$ 10 %		5.38 $\pm$ 10 %	
6000	35.1 $\pm$ 10 %		5.48 $\pm$ 10 %	

### 7.2 SAR MEASUREMENT RESULT WITH HEAD LIQUID

At those frequencies, the target SAR value can not be generic. Hereunder is the target SAR value defined by MVG, within the uncertainty for the system validation. All SAR values are normalized to 1 W net power. In bracket, the measured SAR is given with the used input power.

Page: 7/13

*This document shall not be reproduced, except in full or in part, without the written approval of MVG.  
The information contained herein is to be used only for the purpose for which it is submitted and is not to be released in whole or part without written approval of MVG.*



SAR REFERENCE WAVEGUIDE CALIBRATION REPORT

Ref: ACR.273.5.18.SATU.A

Software	OPENSAR V4
Phantom	SN 20/09 SAM71
Probe	SN 18/11 EPG122
Liquid	Head Liquid Values 5200 MHz: eps' :35.64 sigma : 4.67 Head Liquid Values 5400 MHz: eps' :36.44 sigma : 4.87 Head Liquid Values 5600 MHz: eps' :36.66 sigma : 5.17 Head Liquid Values 5800 MHz: eps' :35.31 sigma : 5.31
Distance between dipole waveguide and liquid	0 mm
Area scan resolution	dx=8mm/dy=8mm
Zoon Scan Resolution	dx=4mm/dy=4m/dz=2mm
Frequency	5200 MHz 5400 MHz 5600 MHz 5800 MHz
Input power	20 dBm
Liquid Temperature	21 °C
Lab Temperature	21 °C
Lab Humidity	45 %

Frequency (MHz)	1 g SAR (W/kg)		10 g SAR (W/kg)	
	required	measured	required	measured
5200	159.00	165.77 (16.58)	56.90	57.20 (5.72)
5400	166.40	173.20 (17.32)	58.43	59.22 (5.92)
5600	173.80	179.61 (17.96)	59.97	60.98 (6.10)
5800	181.20	186.77 (18.68)	61.50	62.84 (6.28)

SAR MEASUREMENT PLOTS @ 5200 MHz

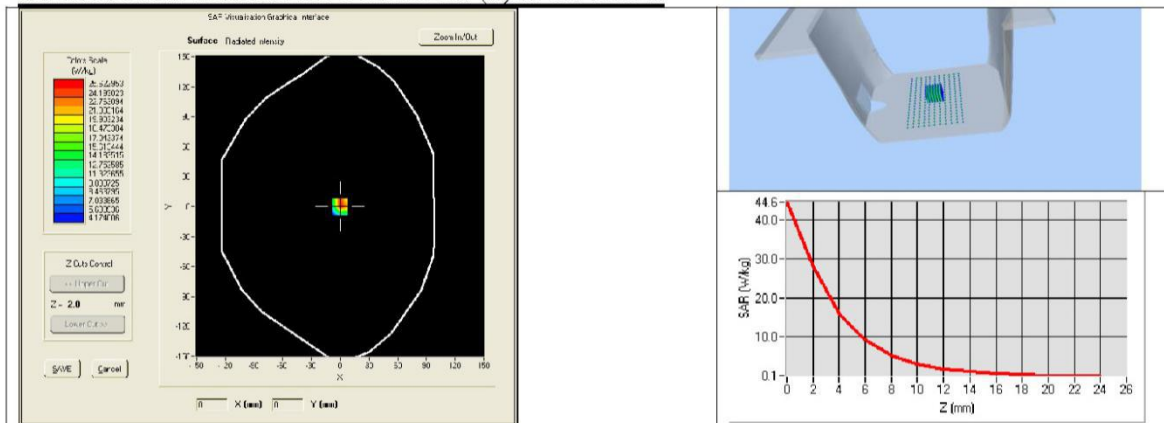

This document shall not be reproduced, except in full or in part, without the written approval of MVG. The information contained herein is to be used only for the purpose for which it is submitted and is not to be released in whole or part without written approval of MVG.



SAR REFERENCE WAVEGUIDE CALIBRATION REPORT

Ref: ACR.273.5.18.SATU.A

**SAR MEASUREMENT PLOTS @ 5400 MHz**

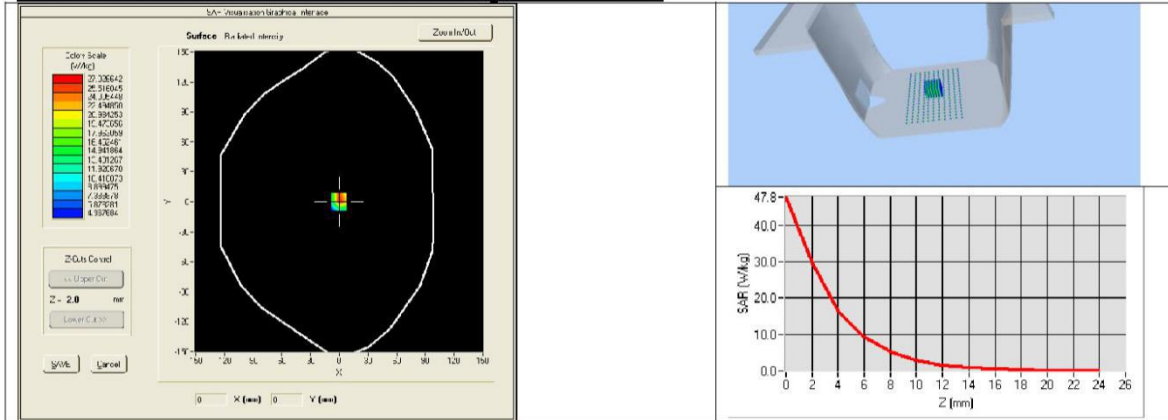

**SAR MEASUREMENT PLOTS @ 5600 MHz**

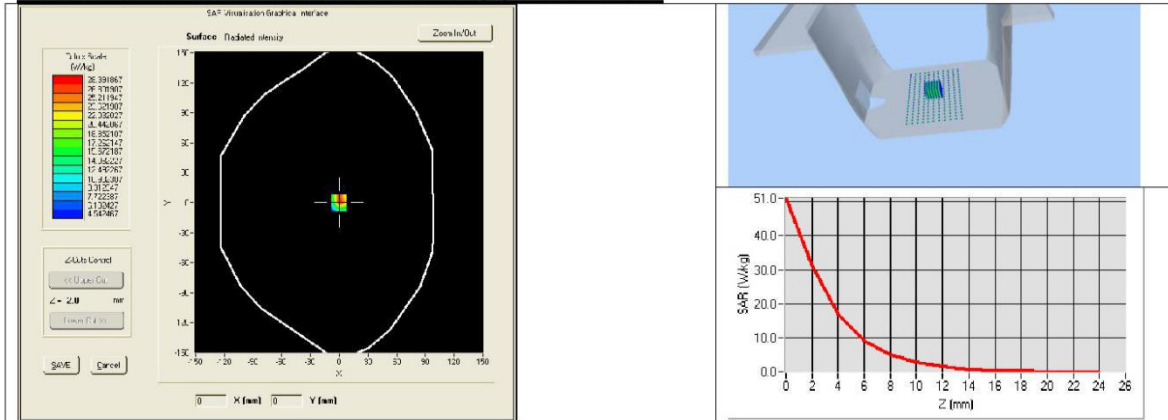

**SAR MEASUREMENT PLOTS @ 5800 MHz**

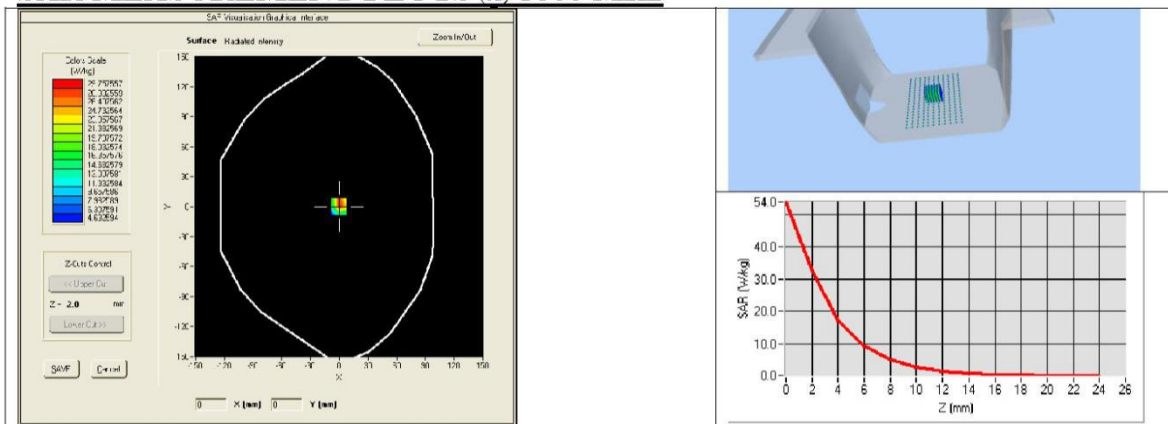

This document shall not be reproduced, except in full or in part, without the written approval of MVG. The information contained herein is to be used only for the purpose for which it is submitted and is not to be released in whole or part without written approval of MVG.



## SAR REFERENCE WAVEGUIDE CALIBRATION REPORT

Ref: ACR.273.5.18.SATU.A

## 7.3 BODY LIQUID MEASUREMENT

Frequency MHz	Relative permittivity ( $\epsilon_r'$ )		Conductivity ( $\sigma$ ) S/m	
	required	measured	required	measured
5200	49.0 $\pm$ 10 %	PASS	5.30 $\pm$ 10 %	PASS
5300	48.9 $\pm$ 10 %		5.42 $\pm$ 10 %	
5400	48.7 $\pm$ 10 %	PASS	5.53 $\pm$ 10 %	PASS
5500	48.6 $\pm$ 10 %		5.65 $\pm$ 10 %	
5600	48.5 $\pm$ 10 %	PASS	5.77 $\pm$ 10 %	PASS
5800	48.2 $\pm$ 10 %	PASS	6.00 $\pm$ 10 %	PASS

## 7.4 SAR MEASUREMENT RESULT WITH BODY LIQUID

Software	OPENSAR V4
Phantom	SN 20/09 SAM71
Probe	SN 18/11 EPG122
Liquid	Body Liquid Values 5200 MHz: $\epsilon_r'$ :48.64 sigma : 5.51 Body Liquid Values 5400 MHz: $\epsilon_r'$ :46.52 sigma : 5.77 Body Liquid Values 5600 MHz: $\epsilon_r'$ :46.79 sigma : 5.77 Body Liquid Values 5800 MHz: $\epsilon_r'$ :47.04 sigma : 6.10
Distance between dipole waveguide and liquid	0 mm
Area scan resolution	dx=8mm/dy=8mm
Zoon Scan Resolution	dx=4mm/dy=4m/dz=2mm
Frequency	5200 MHz 5400 MHz 5600 MHz 5800 MHz
Input power	20 dBm
Liquid Temperature	21 °C
Lab Temperature	21 °C
Lab Humidity	45 %

Frequency (MHz)	1 g SAR (W/kg)	10 g SAR (W/kg)
	measured	measured
5200	159.09 (15.91)	56.13 (5.61)
5400	164.56 (16.46)	57.31 (5.73)
5600	172.25 (17.23)	59.72 (5.97)
5800	177.77 (17.78)	61.06 (6.11)

Page: 10/13

*This document shall not be reproduced, except in full or in part, without the written approval of MVG.  
The information contained herein is to be used only for the purpose for which it is submitted and is not to be released in whole or part without written approval of MVG.*



SAR REFERENCE WAVEGUIDE CALIBRATION REPORT

Ref: ACR.273.5.18.SATU.A

**BODY SAR MEASUREMENT PLOTS @ 5200 MHz**

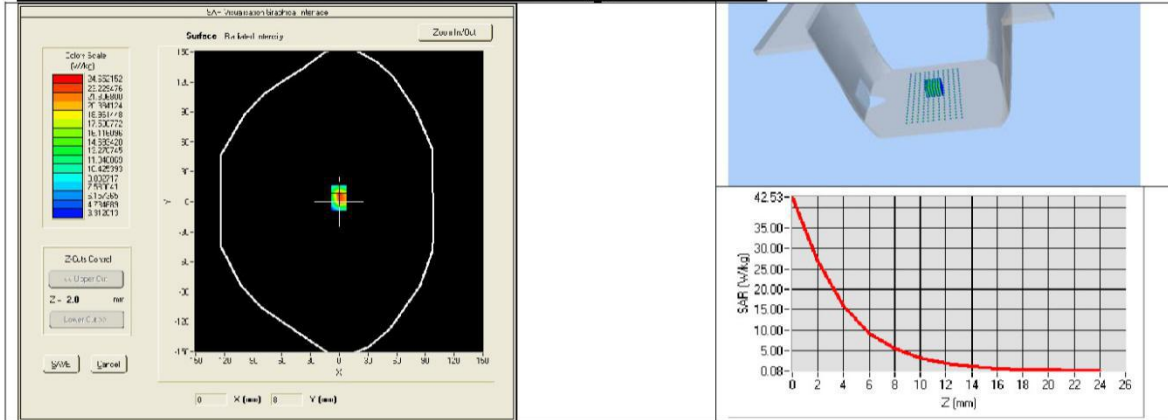

**BODY SAR MEASUREMENT PLOTS @ 5400 MHz**

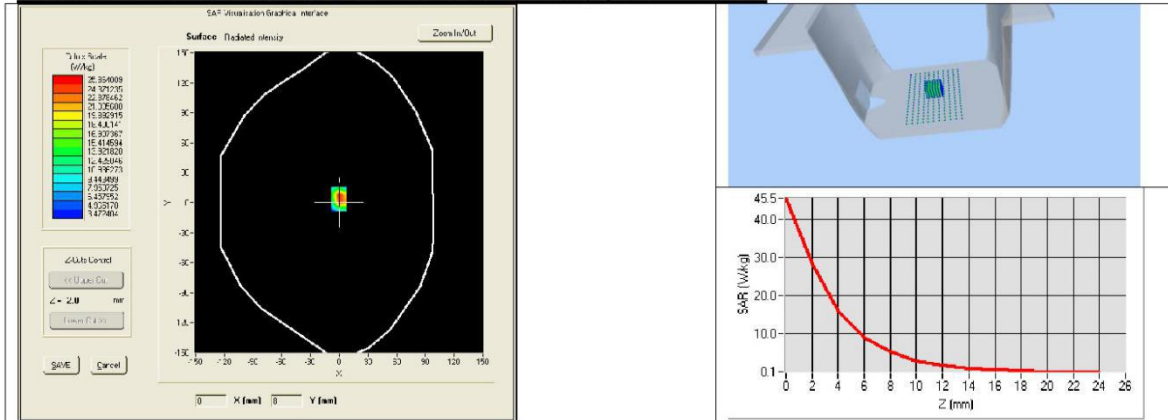

**BODY SAR MEASUREMENT PLOTS @ 5600 MHz**

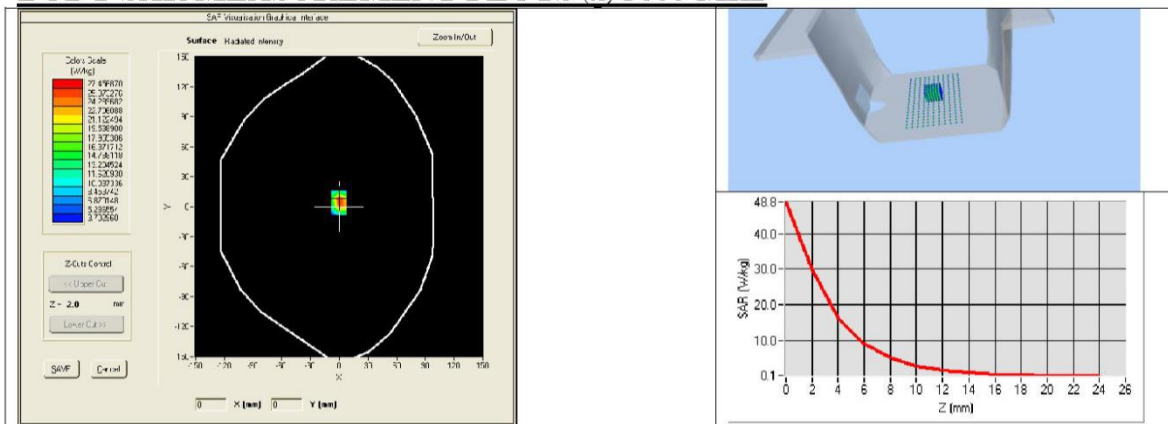

*This document shall not be reproduced, except in full or in part, without the written approval of MVG. The information contained herein is to be used only for the purpose for which it is submitted and is not to be released in whole or part without written approval of MVG.*



SAR REFERENCE WAVEGUIDE CALIBRATION REPORT

Ref: ACR.273.5.18.SATU.A

**BODY SAR MEASUREMENT PLOTS @ 5800 MHz**

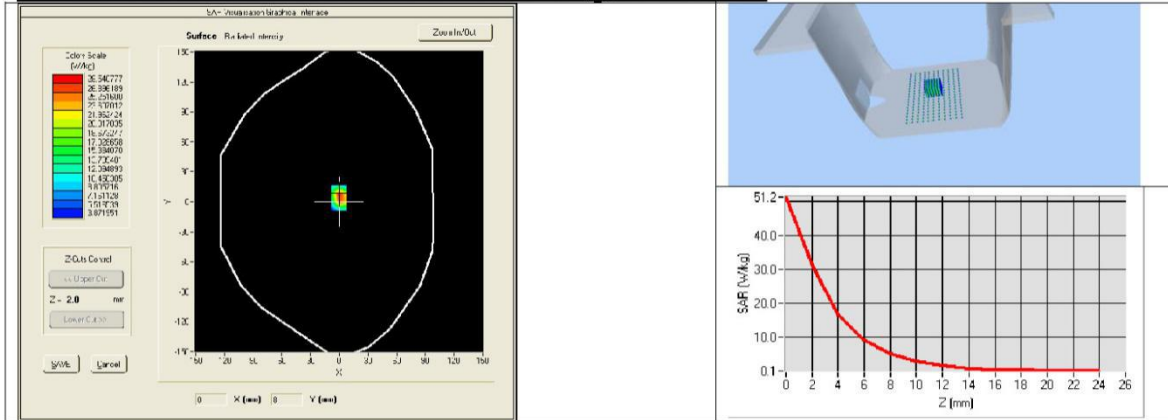

*This document shall not be reproduced, except in full or in part, without the written approval of MVG. The information contained herein is to be used only for the purpose for which it is submitted and is not to be released in whole or part without written approval of MVG.*



## SAR REFERENCE WAVEGUIDE CALIBRATION REPORT

Ref: ACR.273.5.18.SATU.A

## 8 LIST OF EQUIPMENT

Equipment Summary Sheet				
Equipment Description	Manufacturer / Model	Identification No.	Current Calibration Date	Next Calibration Date
Flat Phantom	MVG	SN-20/09-SAM71	Validated. No cal required.	Validated. No cal required.
COMOSAR Test Bench	Version 3	NA	Validated. No cal required.	Validated. No cal required.
Network Analyzer	Rhode & Schwarz ZVA	SN100132	02/2016	02/2019
Calipers	Carrera	CALIPER-01	01/2017	01/2020
Reference Probe	MVG	EPG122 SN 18/11	10/2017	10/2018
Multimeter	Keithley 2000	1188656	01/2017	01/2020
Signal Generator	Agilent E4438C	MY49070581	01/2017	01/2020
Amplifier	Aethercomm	SN 046	Characterized prior to test. No cal required.	Characterized prior to test. No cal required.
Power Meter	HP E4418A	US38261498	01/2017	01/2020
Power Sensor	HP ECP-E26A	US37181460	01/2017	01/2020
Directional Coupler	Narda 4216-20	01386	Characterized prior to test. No cal required.	Characterized prior to test. No cal required.
Temperature and Humidity Sensor	Control Company	150798832	11/2017	11/2020

Page: 13/13

*This document shall not be reproduced, except in full or in part, without the written approval of MVG.  
The information contained herein is to be used only for the purpose for which it is submitted and is not to be released in whole or part without written approval of MVG.*

## 6.SAR System PHOTOGRAPHS



Liquid depth  $\cong$  15cm





## 7.SETUP PHOTOGRAPHS

Right Head Touch View

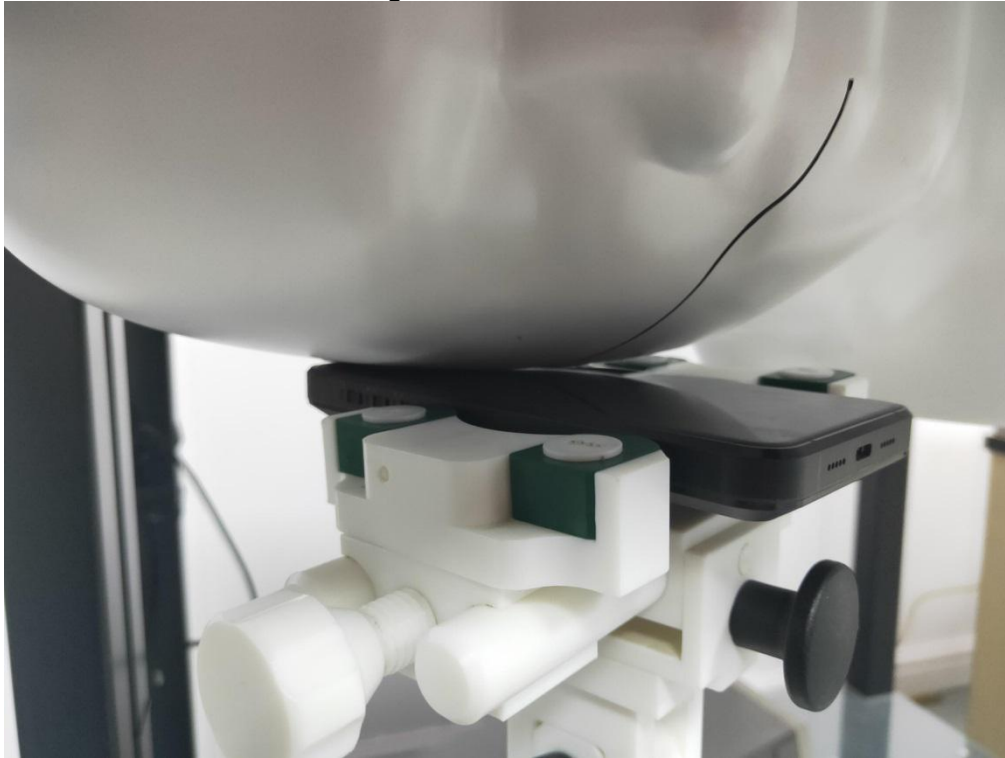

Right Head Tilt View

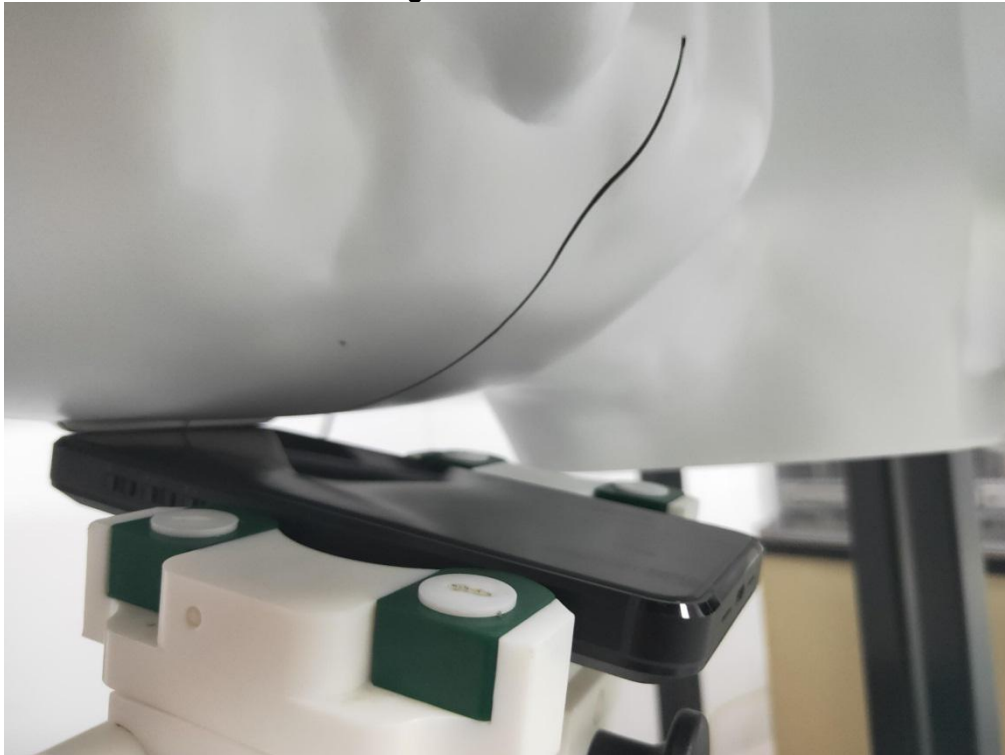

**Left Head Touch View**

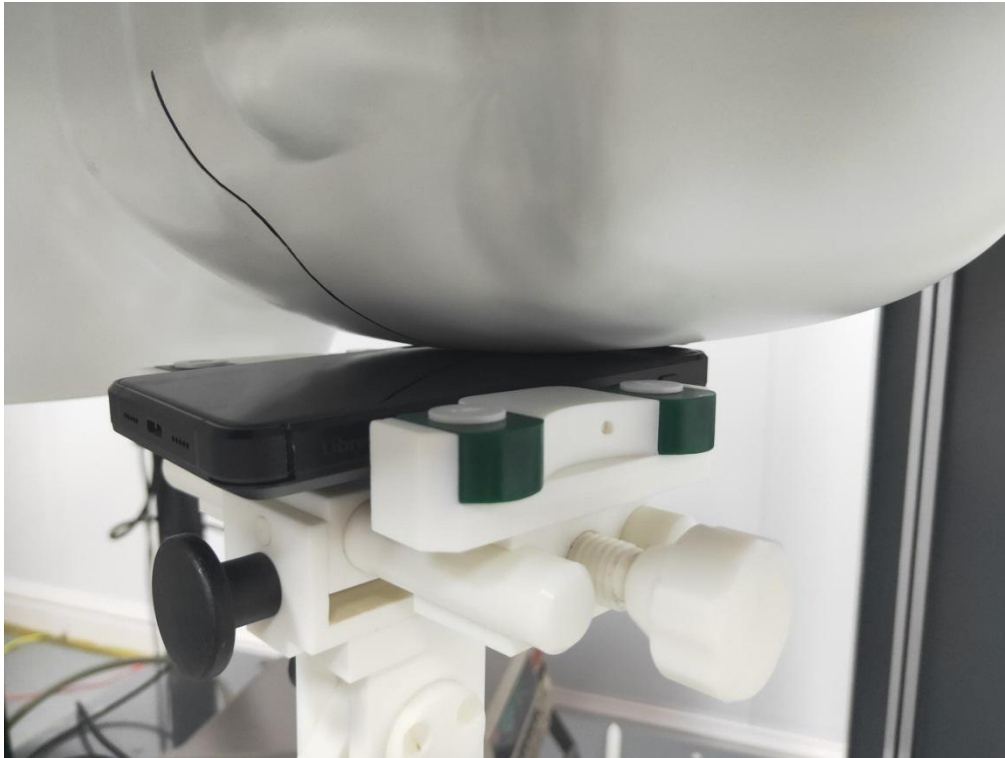

**Left Head Tilt View**

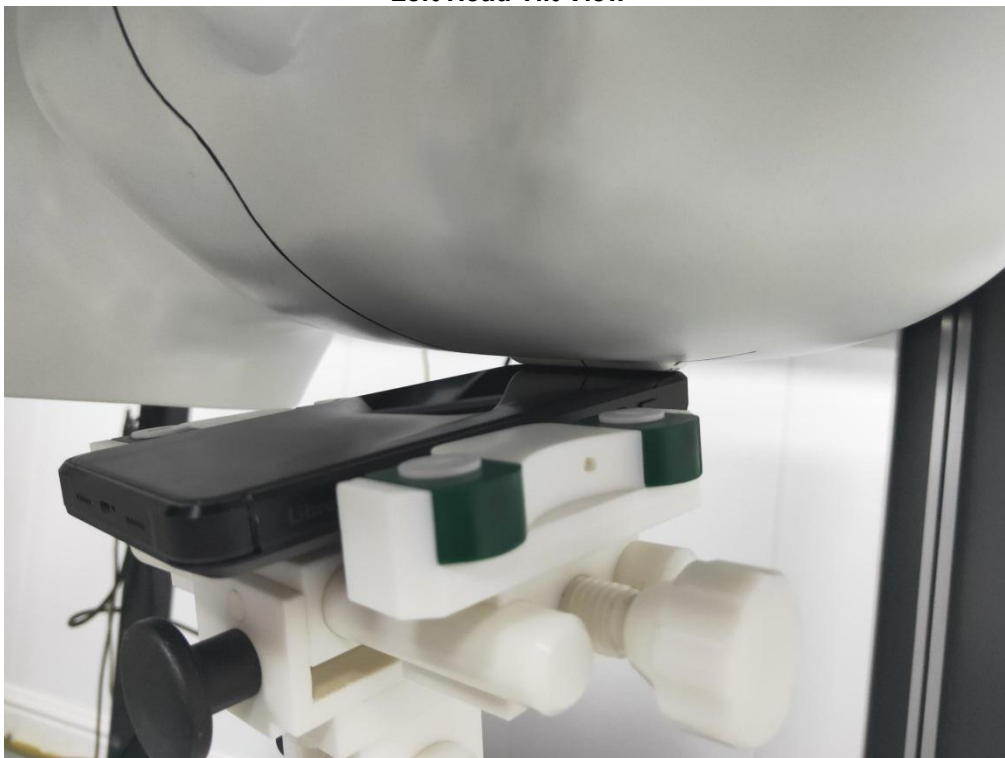

**Body Setup Photo(LCD Front 5mm)**

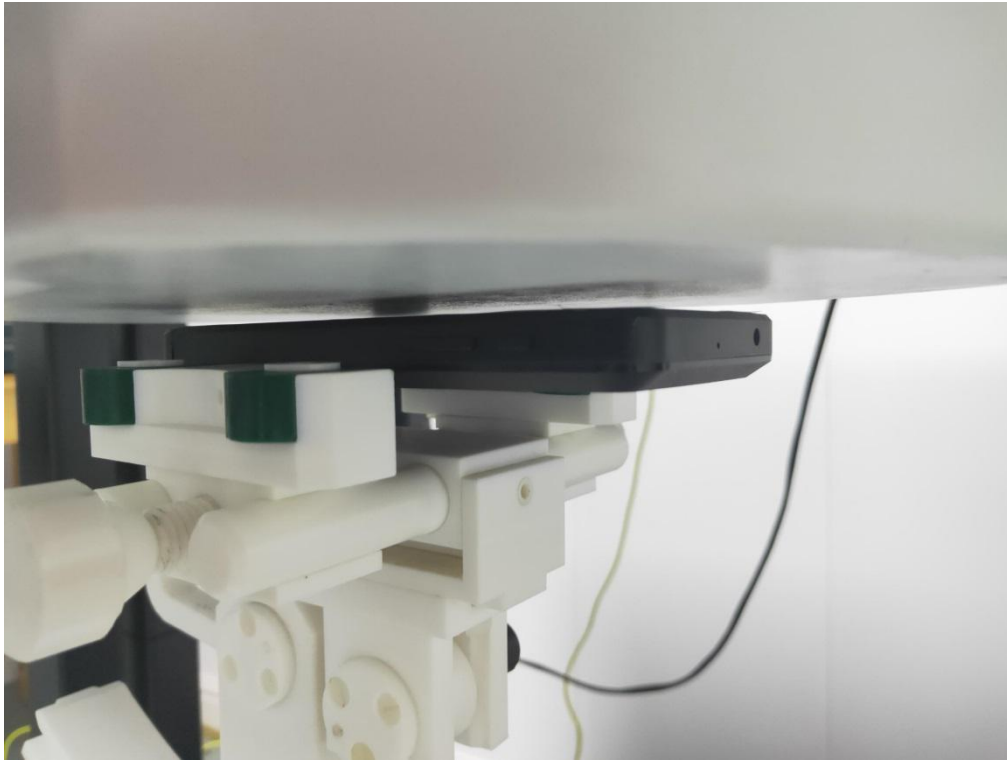

**Body Setup Photo(LCD Rear 5mm)**

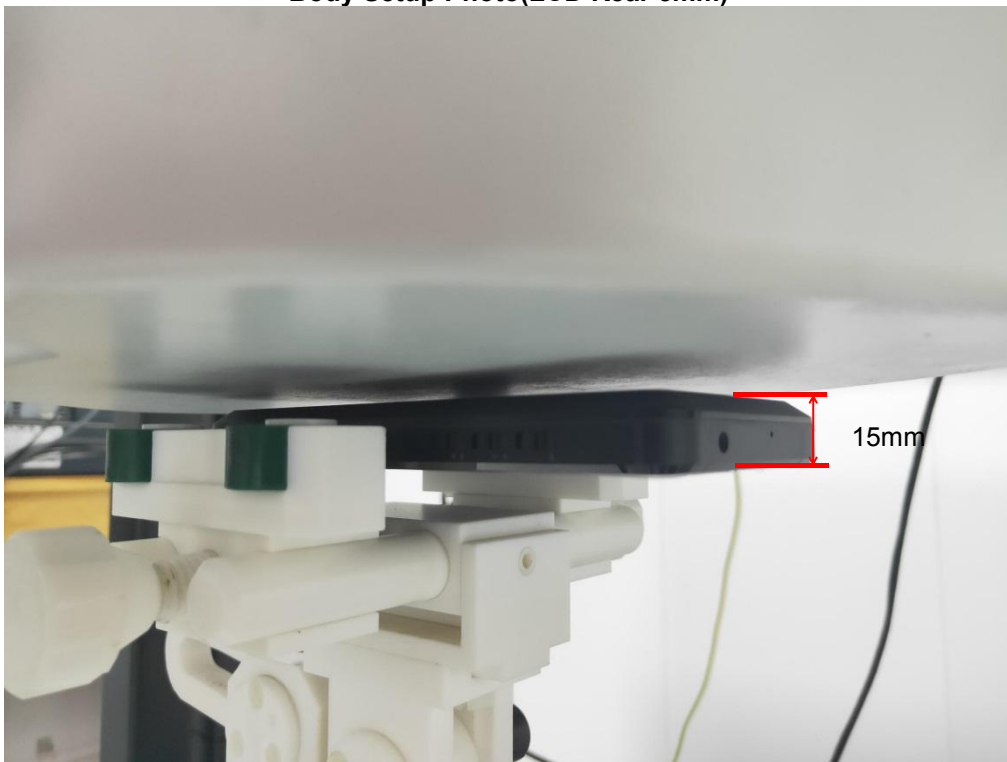

### 8.EUT PHOTOGRAPHS



Fig.1

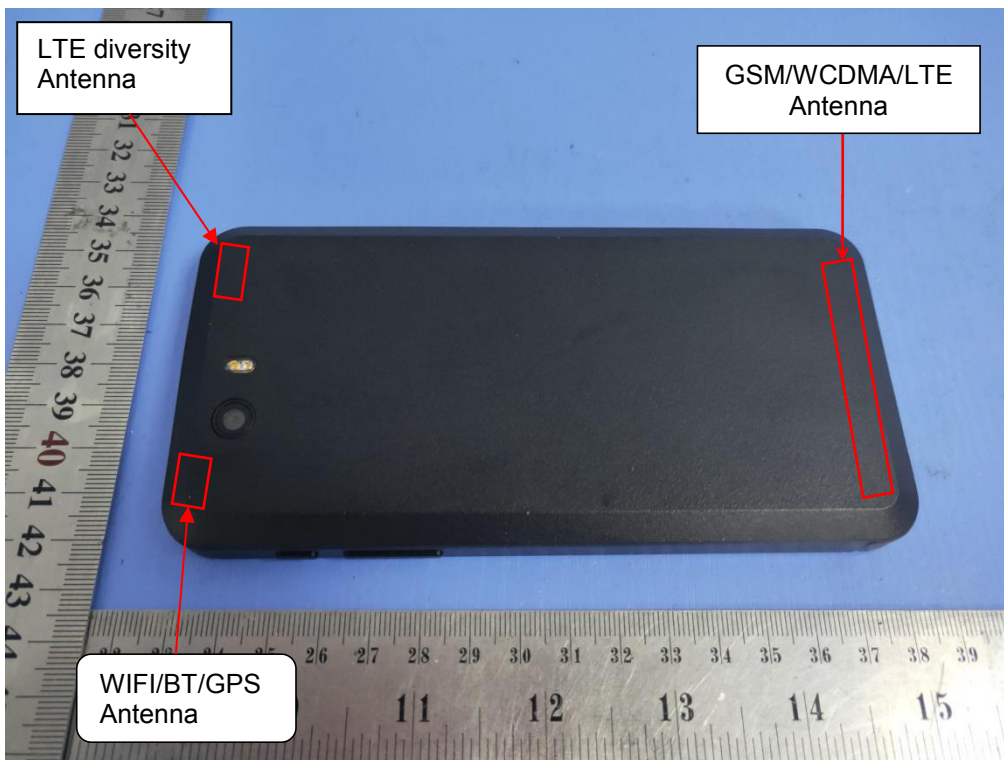

Fig.2

.....The End of Test Report.....